

Table of Contents

- MCF-LW13MIO Operating Manual** 1
- 1. Description** 1
- 2. Overview** 2
 - 2.1 Technical data 2
 - 2.2 Installation 3
 - 2.3 Power supply 4
 - 2.4 Configuration 5
 - 2.5 System leds 6
 - 2.6 Firmware update 6
- 3 I/O** 7
 - 3.1 Input 7
 - 3.2 Output 9
- 4 LoRaWAN® network** 11
 - 4.1 Activation 11
- 5 Configuration** 12
 - 5.1 I/O settings 13
 - 5.2 Other settings 14
 - 5.3 Diagnostic 15
- 6 Passwords** 15
- 7 Configuration file** 16
 - 7.1 Multi devices configuration 17
- 8 LoRaWEB Tool** 18
- 9 Payload** 18
- 10 Ordering code** 19
- 11 Declaration of conformity** 19
- 12 Contacts** 19



MCF-LW13MIO Operating Manual

Important safety information



Read this manual before attempting to install the device! Failure to observe recommendations included in this manual may be dangerous or cause a violation of the law. The manufacturer will not be held responsible for any loss or damage resulting from not following the instructions of this operating manual.

- Do not dismantle or modify in any way.
- Avoid mechanical stress
- Do not use any detergent or alcohol to clean the device.
- Do not mount in horizontal position.

Disposal information for users



Pursuant to and in accordance with Article 14 of the Directive 2012/19/EU of the European Parliament on waste electrical and electronic equipment (WEEE).

The barred symbol of the rubbish bin shown on the equipment indicates that, at the end of its useful life, the product must be collected separately from other waste.

1. Description

This class C device transmits the state of its 16 inputs (12-24Vac/dc) and controls 8 outputs (up to 5A - 230Vac) through the LoRaWAN® network. All these inputs and outputs are galvanically isolated. It can be used for industrial process control, home automation, water treatment, agriculture irrigation and similar applications.



2. Overview

2.1 Technical data

- CPU Cortex M0+
- EEPROM 32KB
- Flash 96KB
- Real time clock
- Encryption AES 128 bit
- Class C LoRaWAN® stack EU868, AS923, AU915, US915
- EU868 version CE certified according to 2014/53/EU – Radio Equipment Directive (RED)
- Transmission band (EU version): 868 MHz
- Transmission Power (EU version): 14dBm max
- Power supply 24Vac/dc
- Maximum power consumption 8W
- 16 opto-isolated input AC-DC, range 5-28Vac/dc
- 8 relay output with COM, NO(5Amp@230Vac), NC(3Amp@230Vac)
- USB for node setup and FW upgrade
- Storage temperature range -20°C ÷ +80°C
- Working temperature range -10°C ÷ +70°C
- DIN (EN 60715) mounting enclosure, 9 modules

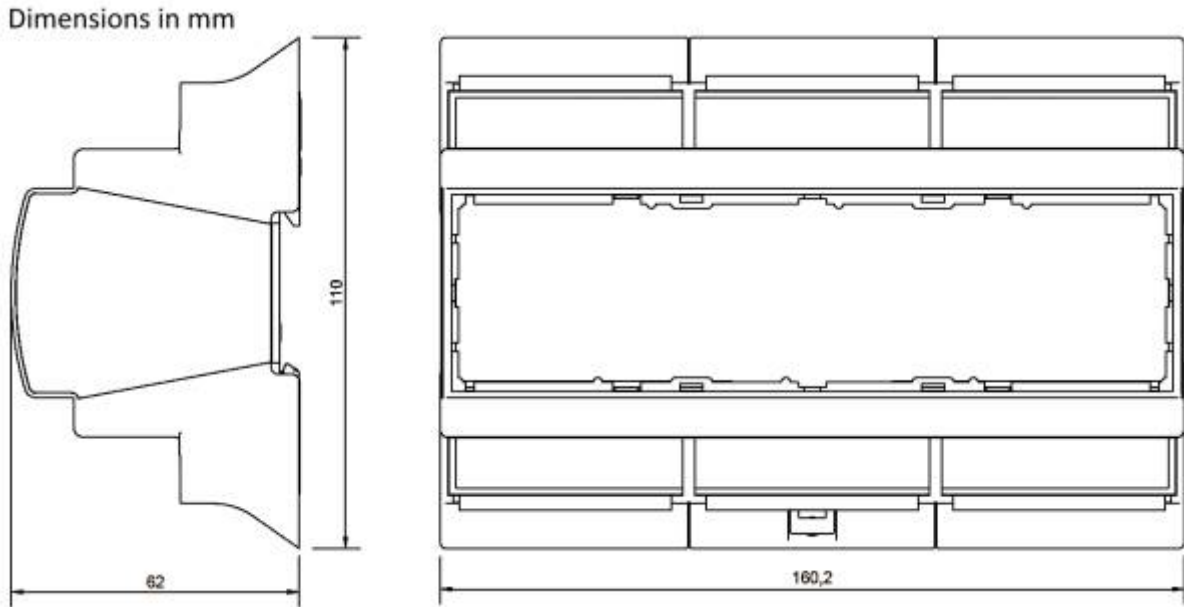

2.2 Installation

The installation has to be done by a qualified electrician.

The device is intended as subassembly (component).

It is responsibility of the assembler of equipment incorporating to ensure that the overall equipment is safe.

The MCF-LW13MIO must be mounted in vertical position.

2.2.1 Antenna

The magnetic antenna must be positioned on a metal body. It should preferably be vertical and at least 30 cm away from other metal bodies. The installation must take place in a place where the LoRaWAN® signal coverage is good (SF=7 optimal, SF=12 weak).



2.3 Power supply



J3

Connector	Pin	Name	Description
J3	9	VSS	Vss reference, power supply dc (-)
	10	VSS	Vss reference, power supply dc (-)
	11	VAC1	Power supply ac and dc (+)
	12	VAC2	Power supply ac only

Valid range is 24Vac/dc ± 10%
 Maximum power consumption: 8W

Connect the power supply to pins 11 and 12 of J3 if ac, pins 11 (+) and 10 (-) if dc.

Power can also be supplied by USB, **only for configuration, not for normal use.**

 **Dip Switches must be OFF.**

2.4 Configuration

To deploy the sensor, use **LoRaWEB** online tool, to setup LoRaWAN® credentials and other preferences (only available for Windows®) :

[LoRaWEB Tool](https://iot.mcf88.cloud/LoRaWeb) (iot.mcf88.cloud/LoRaWeb)

Before connect the device the first time, please install LoRaBridge applications and drivers:

<https://iot.mcf88.cloud/LoRaWeb/#/download>

Validate your settings reading data after the write.

enginko provides user manuals, javascript examples, downlink generator, uplink decoder, different tools and, upon free registration, firmware updates :

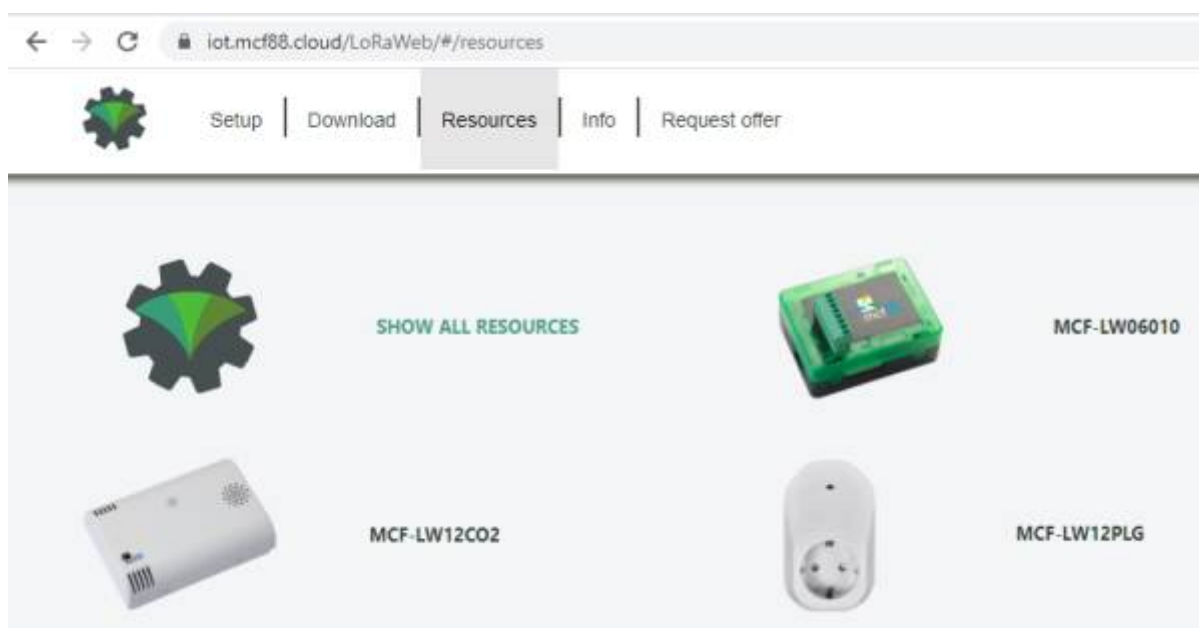

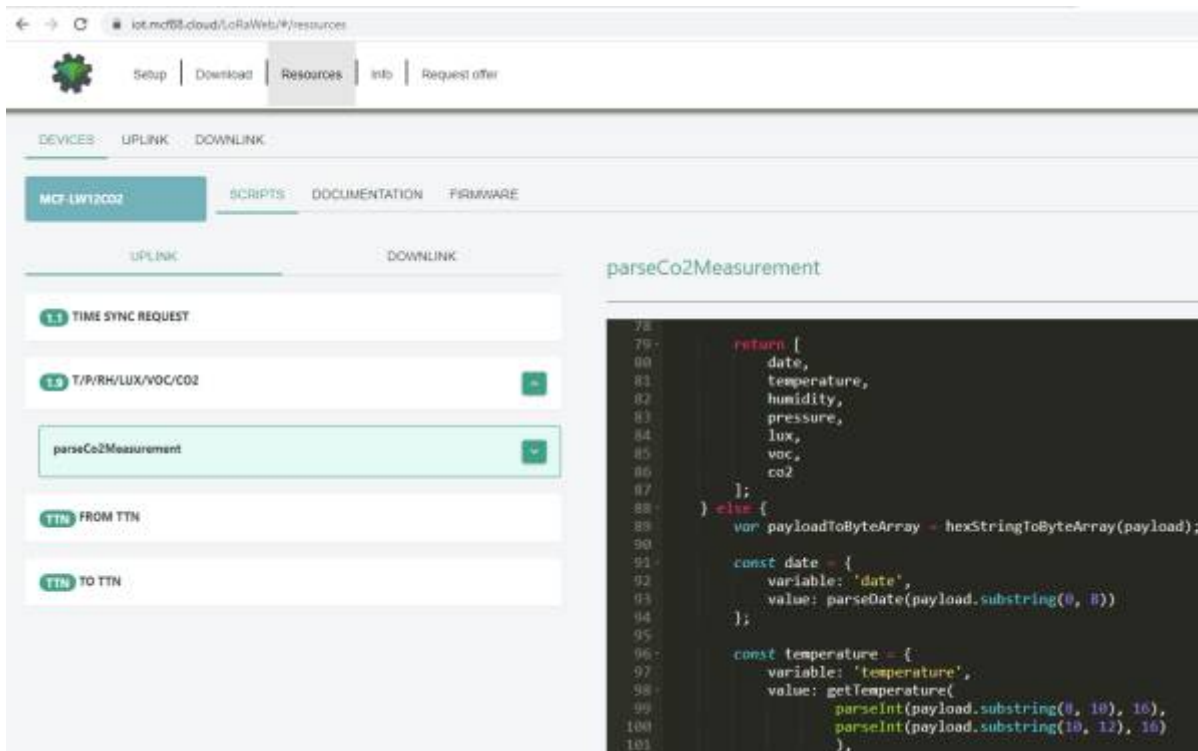

LoRaWAN® not configured		Slow flashing
Joining		Quick flashing
Sending		Quick flashing
Receiving		Quick flashing
Steady state		Fixed
Data error		Flashing 2 seconds
Connection error		Flashing 1 second

2.6 Firmware update

Save the new firmware file (.exe) on the PC, run the file, select the USB FW port and start the update:

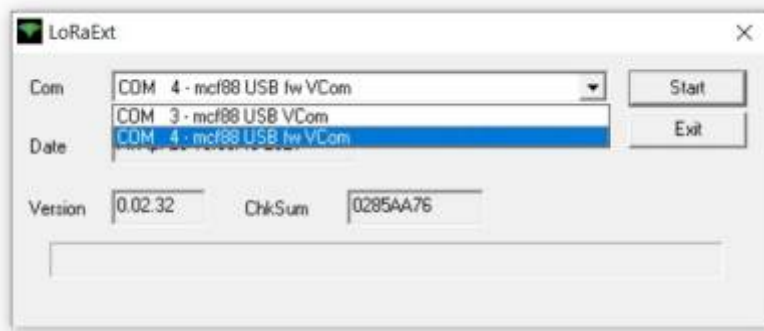

and waiting for the end message.

3 I/O

As default, the device sends a message every time an input or an output changes.

A downlink with new output status forces the device to send back an unblink with the new status. If the output status is the same of current one, the sensor will not send back any message.

Downlink examples (hex):

turn ON the output 1:	0400 0 1 00 0000 0000 0000
turn off the output 1:	0400 0000 0000 0 1 00 0000
receive the current status:	0400 0000 0000 0000 0000

Is possible to set a period (in minutes) to receive a recurrent periodic message with the I/O status.

3.1 Input

Off voltage	0÷2Vac/dc
On Voltage	>5Vac/dc
Maximum input voltage	28Vac/dc
Input current	6mA typ
Max frequency (as counter)	2Hz
Optoinsulation	2500Vac (1 min)



In case of DC input, the positive terminal must be connected to the positive input.

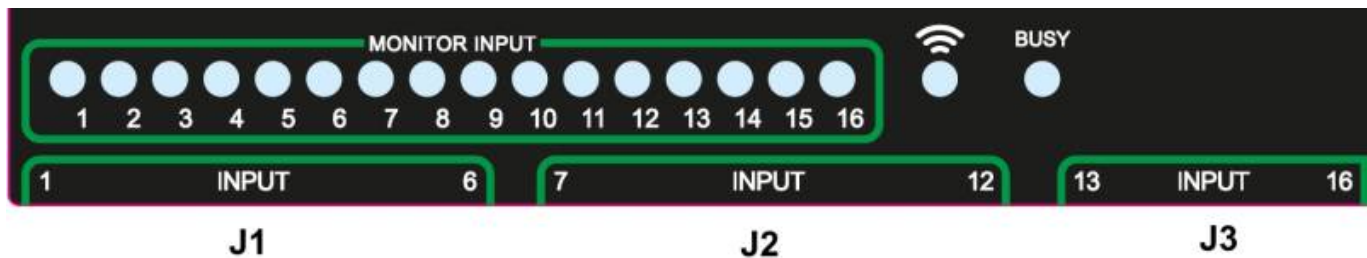

Connector	Pin	Name	Description
J1	1	I+1	Digital input 1 positive
	2	I-1	Digital input 1 negative
	3	I+2	Digital input 2 positive
	4	I-2	Digital input 2 negative
	5	I+3	Digital input 3 positive
	6	I-3	Digital input 3 negative
	7	I+4	Digital input 4 positive
	8	I-4	Digital input 4 negative
	9	I+5	Digital input 5 positive
	10	I-5	Digital input 5 negative
	11	I+6	Digital input 6 positive
	12	I-6	Digital input 6 negative
Connector	Pin	Name	Description
J2	1	I+7	Digital input 7 positive
	2	I-7	Digital input 7 negative
	3	I+8	Digital input 8 positive
	4	I-8	Digital input 8 negative
	5	I+9	Digital input 9 positive
	6	I-9	Digital input 9 negative
	7	I+10	Digital input 10 positive
	8	I-10	Digital input 10 negative
	9	I+11	Digital input 11 positive
	10	I-11	Digital input 11 negative
	11	I+12	Digital input 12 positive
	12	I-12	Digital input 12 negative
Connector	Pin	Name	Description
J3	1	I+13	Digital input 13 positive
	2	I-13	Digital input 13 negative
	3	I+14	Digital input 14 positive
	4	I-14	Digital input 14 negative
	5	I+15	Digital input 15 positive
	6	I-15	Digital input 15 negative
	7	I+16	Digital input 16 positive
	8	I-16	Digital input 16 negative



Input can be used as pulse counters (see settings chapter).

3.2 Output

Contact mode	SPDT
Max. power commutable	1250VA (NO)
	750VA (NC)
Maximum switching voltage	250Vac~
Minimum switching load mW	500mW (10V/5mA)
Min. Number of operation	100.000
Max. current	5A

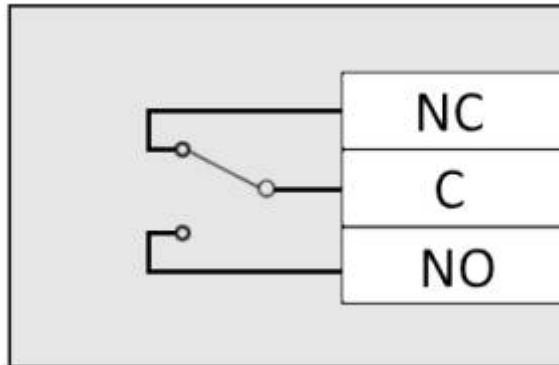

⚠ If driving an inductive load in AC, a Snubber must be provided in parallel to the contacts formed by a RC resistance network = 100Ohm 2w in series with a 100nF 400Volt polyester capacitor. In the case of a DC-controlled load, an anti-parallel diode must be placed on the load (ex. 1N4007). Each line must be protected with a suitable fuse (FUSE).



Connector	Pin	Name	Description
J4	1	NC_1	Normally closed 1
	2	COM_1	Common output 1
	3	NO_1	Normally open 1
	4	NC_2	Normally closed 2
	5	COM_2	Common output 2
	6	NO_2	Normally open 2
	7	NC_3	Normally closed 3
	8	COM3	Common output 3
	9	NO_3	Normally open 3

Connector	Pin	Name	Description
J5	1	NC_4	Normally closed 4
	2	COM_4	Common output 4
	3	NO_4	Normally open 4
	4	NC_5	Normally closed 5
	5	COM_5	Common output 5
	6	NO_5	Normally open 5
	7	NC_6	Normally closed 6
	8	COM6	Common output 6
	9	NO_6	Normally open 6
Connector	Pin	Name	Description
J6	1	NC_7	Normally closed 7
	2	COM_7	Common output 7
	3	NO_7	Normally open 7
	4	NC_8	Normally closed 8
	5	COM_8	Common output 8
	6	NO_8	Normally open 8



The output has pulse capability (minimum pulse duration is 100ms, maximum around 100 minutes), so, instead to send two different commands (one to turn on and one to turn off the output), is possible to send a duration command.

As application example, to safely turn on an output, send a ON-pulse command for a defined time (for example, for the maximum allowed interval), and before the expiring time, another ON-pulse command (making a kind of watchdog) if the output still needs to be ON, or a simply OFF command if you want to turn it off.

3.2.1 Time schedule

It is possible to program the device with a weekly calendar, based on day of the week and time, to turn ON and OFF the output at a defined time:



Setup | Download | Resources | Online documentation | Info | Request offer

Change language | Log in

DEVICES | UPLINK | DOWNLINK | TIME SCHEDULE

Programming

Add new action | View existing time schedule | Save current schedule

#	Label	Week							Feedback	Hours	Outputs								
		Sunday	Monday	Tuesday	Wednesday	Thursday	Friday	Saturday			1	2	3	4	5	6	7	8	
1	Mon-Fri sign ON	🟢	🟢	🟢	🟢	🟢	🟢	🔴	Yes	08:00	🟢	🟡	🟡	🟡	🟡	🟡	🟡	🟡	🟡
2	Sat-Sun sign ON	🟢	🔴	🔴	🔴	🔴	🔴	🟢	Yes	08:30	🟢	🟡	🟡	🟡	🟡	🟡	🟡	🟡	🟡
3	Sat-Sun sign OFF	🟢	🔴	🔴	🔴	🔴	🔴	🟢	Yes	12:30	🔴	🟡	🟡	🟡	🟡	🟡	🟡	🟡	🟡
4	Mon-Fri sign OFF	🔴	🟢	🟢	🟢	🟢	🟢	🔴	Yes	-20:00	🔴	🟡	🟡	🟡	🟡	🟡	🟡	🟡	🟡

and generate and XLS file that can be downloaded by downlinks:

Label	Hour	Minute	Sun	Mon	Tue	Wed	Thu	Fri	Sat	MC	Payload
Mon-Fri sign ON	8	0	0	1	1	1	1	1	0	0	04000100000000000000
Sat-Sun sign ON	8	30	1	0	0	0	0	0	1	0	04000100000000000000
Sat-Sun sign OFF	12	30	1	0	0	0	0	0	1	0	04000000000001000000
Mon-Fri sign OFF	20	0	0	1	1	1	1	1	0	0	04000000000001000000

4 LoRaWAN® network

The sensor is compliant with LoRaWAN® **specification 1.0.2, regional 1.0.2b.**

4.1 Activation

The device supports the following activations on a LoRaWAN® network:

- NONE:** sensor not activated
- OTAA:** the JoinEUI and the AppKey not setted, must be written to the device;
- OTAA MCF88:** Over the air activation, fixed keys: JoinEUI = 904e915000000003, AppKey on request;
- OTAA ENGINKO:** Over the air activation, fixed keys: JoinEUI = 904e915000000003, AppKey on request;
- ABP:** requires writing to the device of NwkSkey, AppSkey, DevAddr.

The device exits factory activated with **NONE** mode. On request devices can be shipped already activated.

Note: in **OTAA** AppKey is write only, in reading the field will always be empty, even if set.

Network settings:

please keep "Any" settings. Change it only if Objenious network is used (default_ any).

Network type:

LoRa syncword can be setted as "private"(0x12) instead "public" (0x34), but the NS must be setted accordingly (default: public).

LoRa Band:

select the right LoRaWAN ® band settings accodngly to country requirements.

5 Configuration



5.1 I/O settings



Status of the output at power on:
select the status of OUTPUT 1 at power-on (default: off).

I/O reading period [min]:
if different from 0, this is the interval (in minutes) between one I/O messages status and the next one. Value can be between 1 and 255 minutes (default: 0 minutes - disabled). Period interval can be set with LoRaWEB or with downlink command.

Number of counter inputs:

Number of inputs used as pulses counters. Value = 1 means that input 1 is a pulses counter, value = 3 means the first 3 inputs are pulses counter . (default: 0).

Counters reading period [min]:

if counter enabled, this is the interval (in minutes) between one measure and the next one. The sensor sends one measures for every transmission. Value can be between 1 and 255 minutes (default: 0 minutes).

Period interval can be set with LoRaWEB or with downlink command.

5.2 Other settings

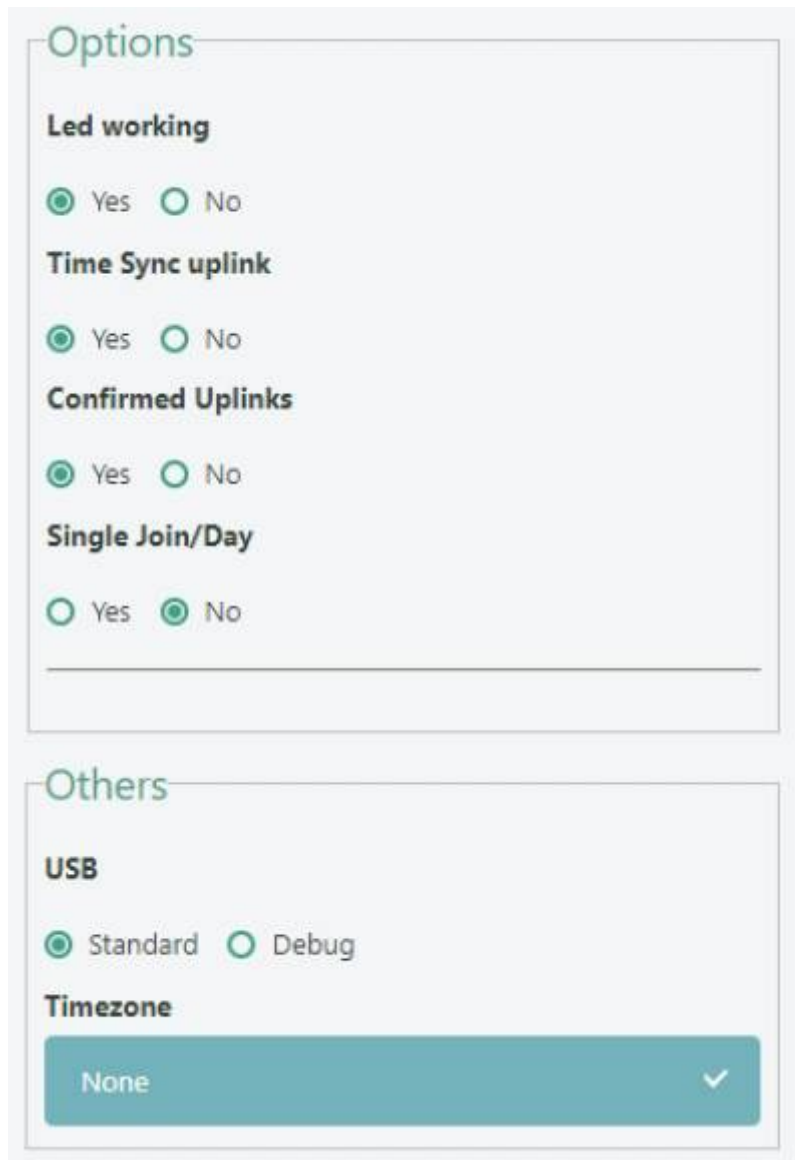

Led working:

enable/disable status led (default: enabled).

Time Sync uplink:

enable/disable time synchronization request (default: enabled).



Normally sensor asks for a time sync at every power on (uplink starting with 01) or, if enabled, once a week.

Please check chapter 2.1 [DATA FRAME FORMAT](#).

Confirmed uplinks:

set for confirmed uplinks (default: confirmed uplink).

Single join/day:

set for to allow only one join per day (default: multiple join allowed).

USB:

change USB port function (default: Standard).

Timezone:

set to change DST (default: none).

5.3 Diagnostic

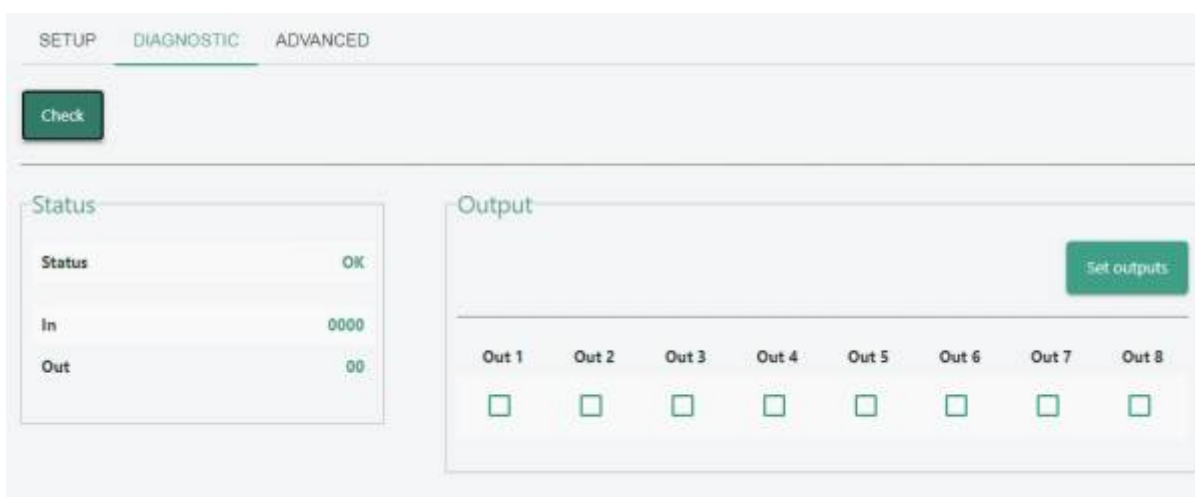

6 Passwords

The device can be protected by passwords, to avoid unauthorized persons to read data or modify parameters.

As default passwords are equal to 0.

Allowed values range from 0 to 999999999 (only numbers).

To change the passwords, set the new values with LoRaWEB:

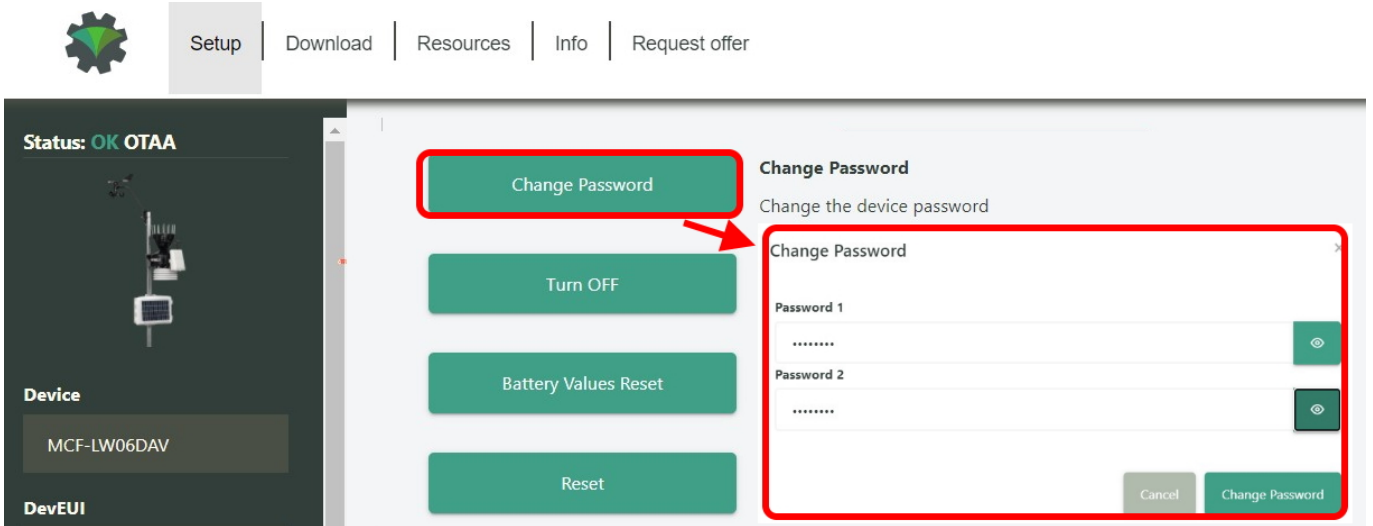

Once the passwords are setted, to gain access from LoRaWEB to the sensor, set the right values before reading from the device:

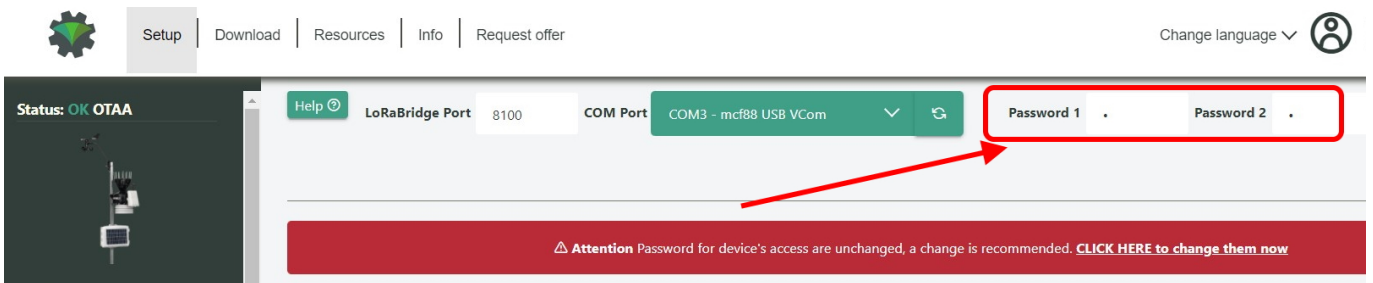

To bring back the sensor to factory default and reset the passwords, a reset code must be requested to enginko (please provide the DevEUI of the sensor when you ask for that code).

7 Configuration file

With LoRaWEB is possible to configure the device using an XML file, instead to manually adjust the parameters (for details about the file format please ask to enginko). This is very useful especially in case of multiple devices configuration.

With "Save" button an XML file with the actual configuration of the sensor will be generated. This is useful to store or clone the configuration, or to send it to enginko's support if needed.

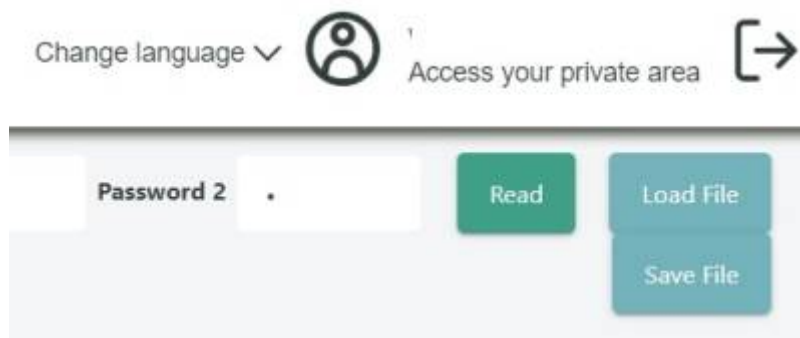

7.1 Multi devices configuration

With LoRaWEB is possible to configure many devices in an easy way.

For multi-configuration is needed at least one XML file with the parameters to set.

Settings on this file will be applied to all the sensors.

With an additional XLS file is possible to load different LoRa configuration parameters (Activation Type, AppKey, AppEUI, NetKey, DevAddress, Band, Private option) for each sensor, based on DevEUI.

XLS is prevailing on the XML, so if both files are enabled, if the DevEUI of the device matches one of the DevEUIs in the XLS file, LoRa parameters will be setted from this one.

These configuration can be done in the in the Settings:

- Use of the general configuration by file;
- Use of the specific configuration by file.

Configure from file

This feature allows you to configure a device via Excel files (.xls) and XML

Configure

Check Excel files

Yes No

Upload Excel files (.xls) for LoRaWAN® parameters configuration

Choose File ... **Load File**

[Download Excel template \(.xls\) for a LoRaWAN® specific configuration by DevEUI](#)

Check XML file

Yes No

Upload XML file for the generic configuration of the device

Choose File ... **Load File**

For details on files format please ask to enginko.

8 LoRaWEB Tool

enginko provides, upon free registration, **LoRaWEB** online tool, where for each sensor it is possible to find documentation, javascript examples for parsing, downlink generator and uplink decoder:

[LoRaWEB Tool](https://iot.mcf88.cloud/LoRaWeb) (iot.mcf88.cloud/LoRaWeb)

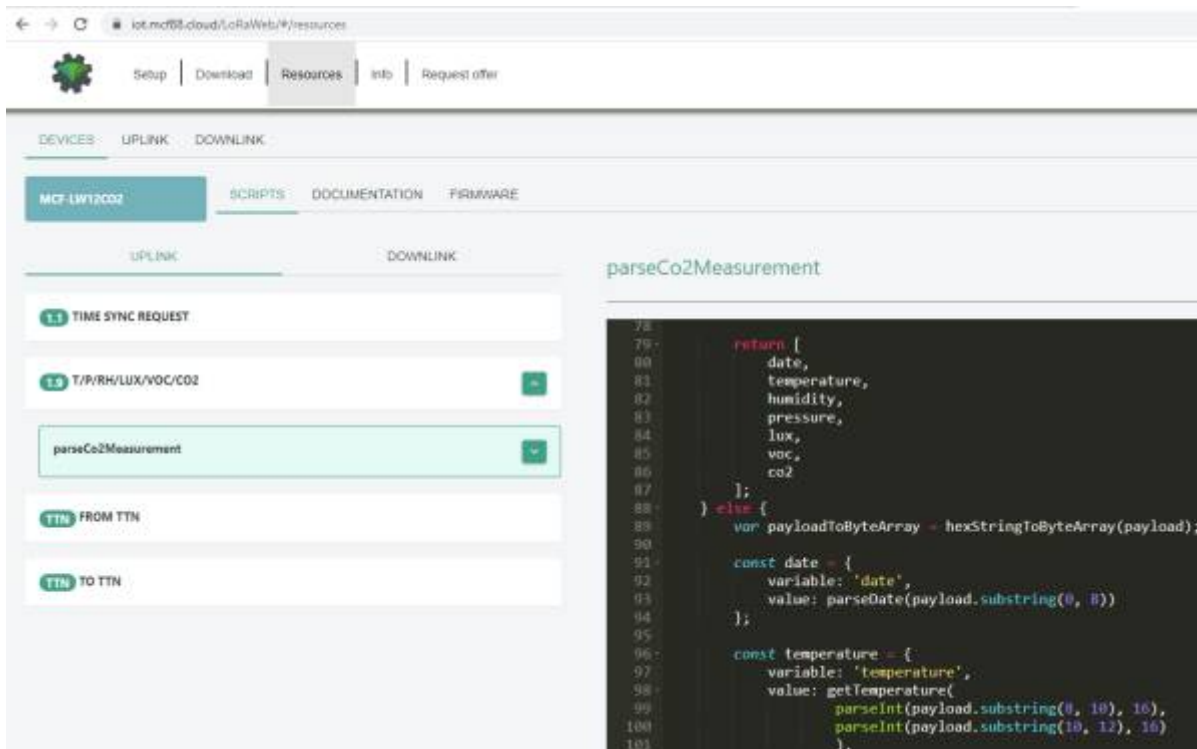
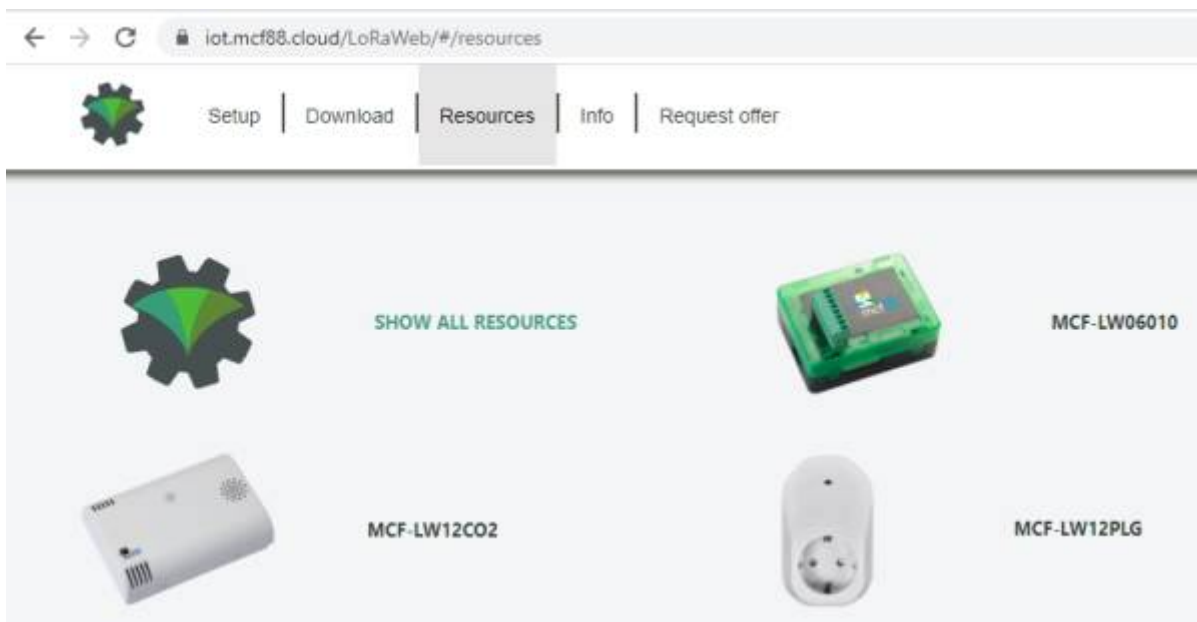

9 Payload

For payload descriptions, uplinks and downlinks format and available commands please refer to this

document:

[DATA FRAME FORMAT](#)

10 Ordering code

Code	Description
MCF-LW13MIO	enginko LoRaWAN® multi I/O module EU863-870
MCF-LW13MIO-AS	enginko LoRaWAN® multi I/O module AS920-925
MCF-LW13MIO-US	enginko LoRaWAN® multi I/O module US902-928
MCF-LW13MIO-AU	enginko LoRaWAN® multi I/O module AU915-928
MCF-LW13MIO-WW	enginko LoRa multi I/O module 2.4GHz

11 Declaration of conformity

Hereby, enginko Srl declares that MCF-LW13MIO complies with the essential requirements and other relevant provisions of Directive 2014/53/EU.

12 Contacts

enginko Srl

Via Roma 3 I-28060 Sozzago (NO)

T : +39 0321 15 93 088

E : info@enginko.com

PEC: enginkosrl@legalmail.it

W: enginko.com

rev. 0

From:

<https://enginko.com/support/> - **enginko.support.center**

Permanent link:

https://enginko.com/support/doku.php?id=manual_mcf-lw13mio&rev=1682078775

Last update: **2023/05/29 07:33**

