

Table of Contents

- MCF-LW12TERPM Operating Manual** 1
- 1. Description** 1
- 2. Overview** 2
 - 2.1 Technical data 2
 - 2.2 Installation 3
 - 2.3 Configuration 4
 - 2.4 Power ON/OFF 4
 - 2.5 Backup battery 6
 - 2.6 Firmware update 7
- 3. Measures** 9
 - 3.1 Period 10
 - 3.2 Temperature 10
 - 3.3 Pressure 10
 - 3.4 Humidity 11
 - 3.5 PM 11
- 4 LoRaWAN network** 12
 - 4.1 Activation 13
 - 4.2 Other settings 14
- 5 Passwords** 15
- 6 Configuration file** 18
 - 6.1 Multi devices configuration 19
- 7 LoRaWEB Tool** 20
- 8 Payload** 21
- 9 Maintenance** 21
- 10 Ordering code** 22
- 11 Declaration of conformity** 22
- 12 Contacts** 22



MCF-LW12TERPM Operating Manual

Important safety information



Read this manual before attempting to install the device! Failure to observe recommendations included in this manual may be dangerous or cause a violation of the law. The manufacturer will not be held responsible for any loss or damage resulting from not following the instructions of this operating manual.

- Do not dismantle or modify in any way.
- The device is not intended to be used as a reference sensor, and Angel4Future Srl will not be held liable for any damage which may result from inaccurate readings.
- Avoid mechanical stress
- Do not use any detergent or alcohol to clean the device.

Disposal information for users



Pursuant to and in accordance with Article 14 of the Directive 2012/19/EU of the European Parliament on waste electrical and electronic equipment (WEEE), and pursuant to and in accordance with Article 20 of the Directive 2013/56/EU of the European Parliament on batteries and accumulators and waste batteries.

The barred symbol of the rubbish bin shown on the equipment indicates that, at the end of its useful life, the product must be collected separately from other waste.

Please note that the lithium batteries must be removed from the equipment before it is given as waste and disposed separately. To remove the batteries refer to the specifications in the user manual. For additional information and how to carry out disposal, please contact the certified disposal service providers.

1. Description

The MCF-LW12TERPM is a solar powered sensor that reads temperature, humidity, pressure and PM (PM1, PM2.5, PM10) and sends collected data over the LoRaWAN® network. Ideally suited for a wide range of applications such as weather stations, urban monitoring, air quality, industrial, environmental or farming projects.



2. Overview

2.1 Technical data

- CPU Cortex M0+
- EEPROM 32Kb
- Flash 64k
- Encryption AES 128 bit
- Class A LoRaWAN® 1.0.2 stack EU868, AS923, AU915, US915
- Transmission Power (EU version): 14dBm max
- Temperature -30 ÷ 70°C (0 ÷ 65°C ±1.0°C)
- Humidity 0% to 100% will following error @25°C:
 - From 0% to 20% ±5%
 - From 20% to 80% ±3%
 - From 80% to 100% ±5%
- Pressure 300 ÷ 1100hPa (±1.0hPa)
- PM1\PM2.5 ±10 µg/m3 (0 ÷ 100 µg/m3) o ±10% (100 ÷ 1000 µg/m3)
- PM10 ±25 µg/m3 (0 ÷ 100 µg/m3) o ±25% (100 ÷ 1000 µg/m3)
- NFC for IoT node setup, FW upgrade and data reading
- main 860mAh Li-Ion rechargeable battery and a 7200mAh Li-SOCI2 primary battery as backup
- > 30 days of operation with no sun with main battery fully charged (20 hours of of direct sunlight)

- Wall or pole mounting
- Storage temperature range -30 + 80°C
- Working temperature range -30 + 60°C
- Protection class IP33
- Dimensions (approx) L x H X P: 210 x 310 x 200mm
- Weight 2.5kg

2.2 Installation

The installation must take place in a place where the LoRaWAN® signal coverage is good (SF=7 optimal, SF=12 weak).

Place the sensor in a way that the solar panel is not in the shade and exposed to the greatest possible amount of sunlight during the day.

2.2.1 Pipe mount

Mount the sensor on pipe as in picture:

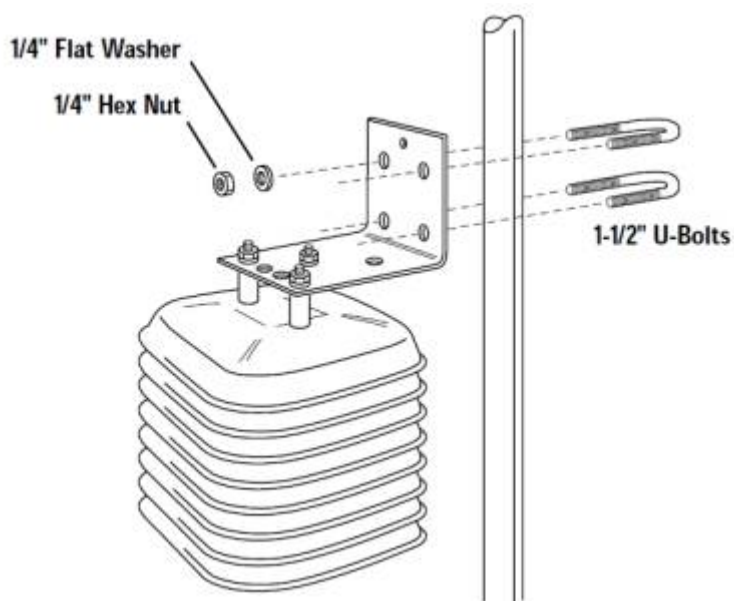

2.2.2 Wall mount

Mount the sensor on wall as in picture:

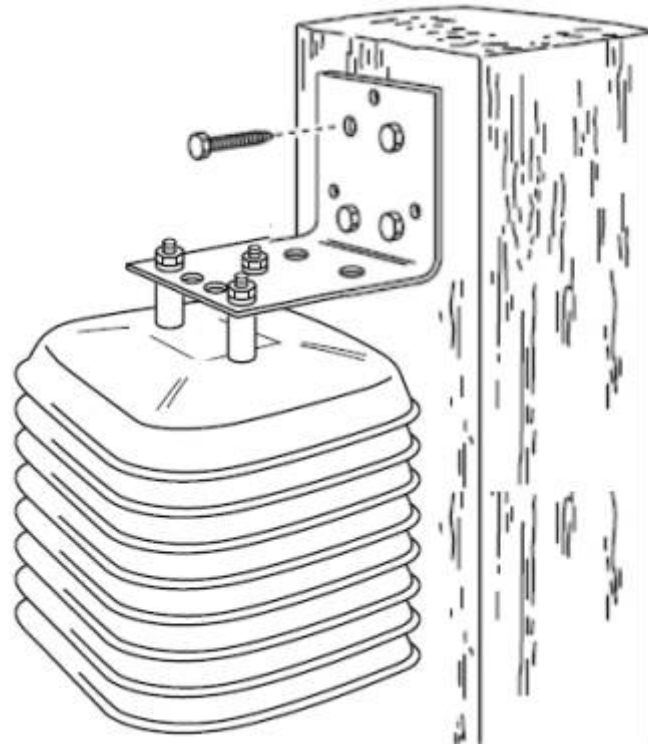

2.3 Configuration

To deploy the sensor, download the latest **LoRa Tool** Android App to setup LoRaWAN® credentials and other preferences :



Always validate your settings by reading the NFC data after the sensor has restarted.

Configuration can be done only via NFC.
No USB port available for the user.

2.4 Power ON/OFF

The sensor is shipped completely off to prevent battery consumption during storage. It is therefore necessary to carry out a first power-on prior to commissioning.

Move the NFC antenna of the mobile (the exact position varies depending on the model of the smartphone) to the sensor antenna, in the area shown in the figure:



At the first power-on, sensor will take from 1 to 5 minutes to give an effective measure of PM.

In case of long period inactivity, if necessary, is possible to shut-off again the sensor to prevent battery consumption, via downlink or with LoRa Tool App:



After configuration, turn OFF the sensor (using LoRa Tool) if not used, to avoid unwanted battery discharge:

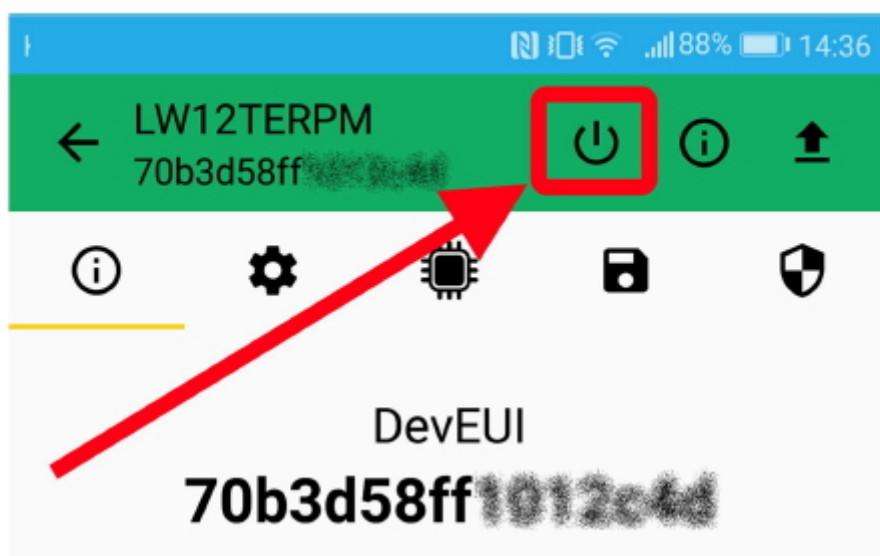

2.5 Backup battery

This sensor contains lithium battery, which must be disposed of separately.

MCF-LW12TERPM is provided with one Li-SOCI2 battery pack as backup:

Code	Description
MCF-1S2PE	7200mAh battery pack

With this battery the sensor can run for 1 year with the rechargeable battery completely discharged.

Battery replacement can be done only by Angel4Future or trained personnel.

2.6 Firmware update

Download the latest firmwares available on the smartphone with LoRaTool app:

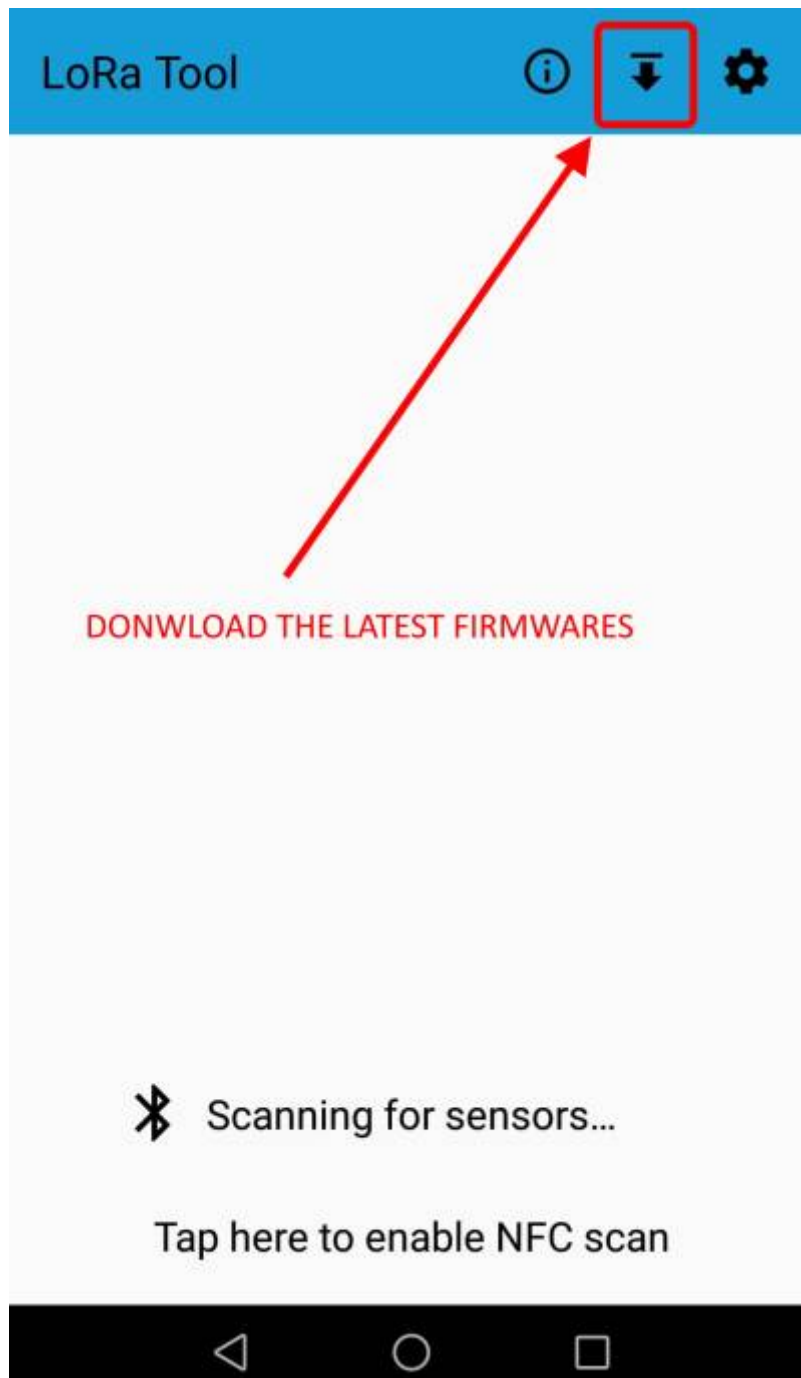

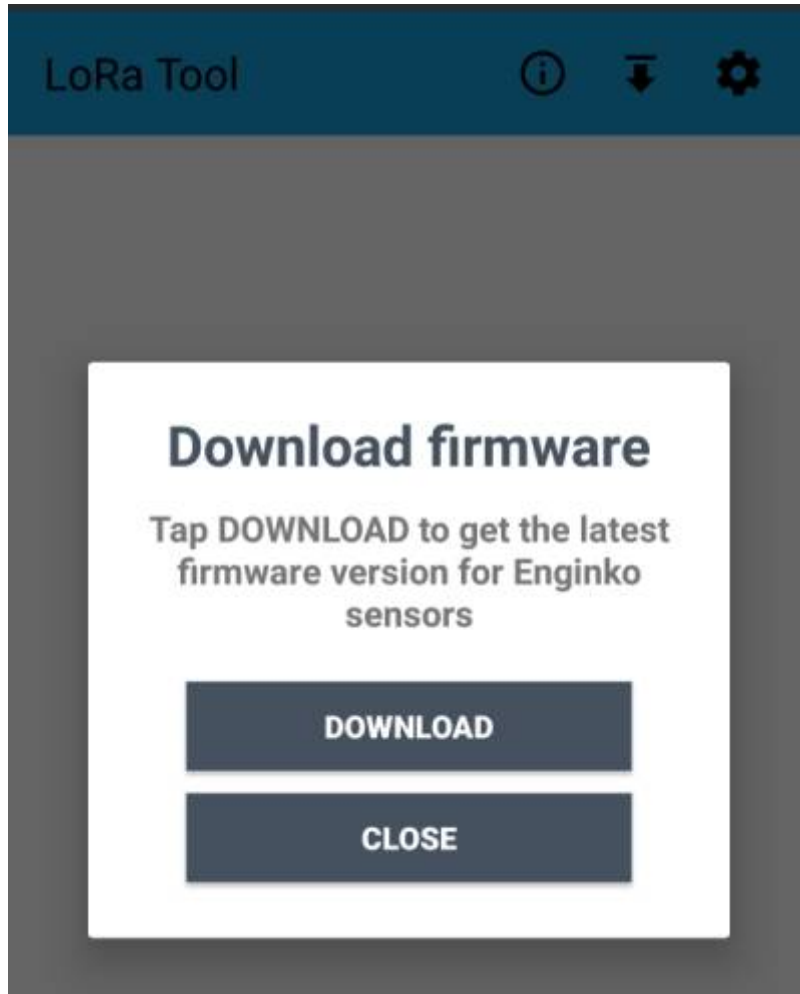

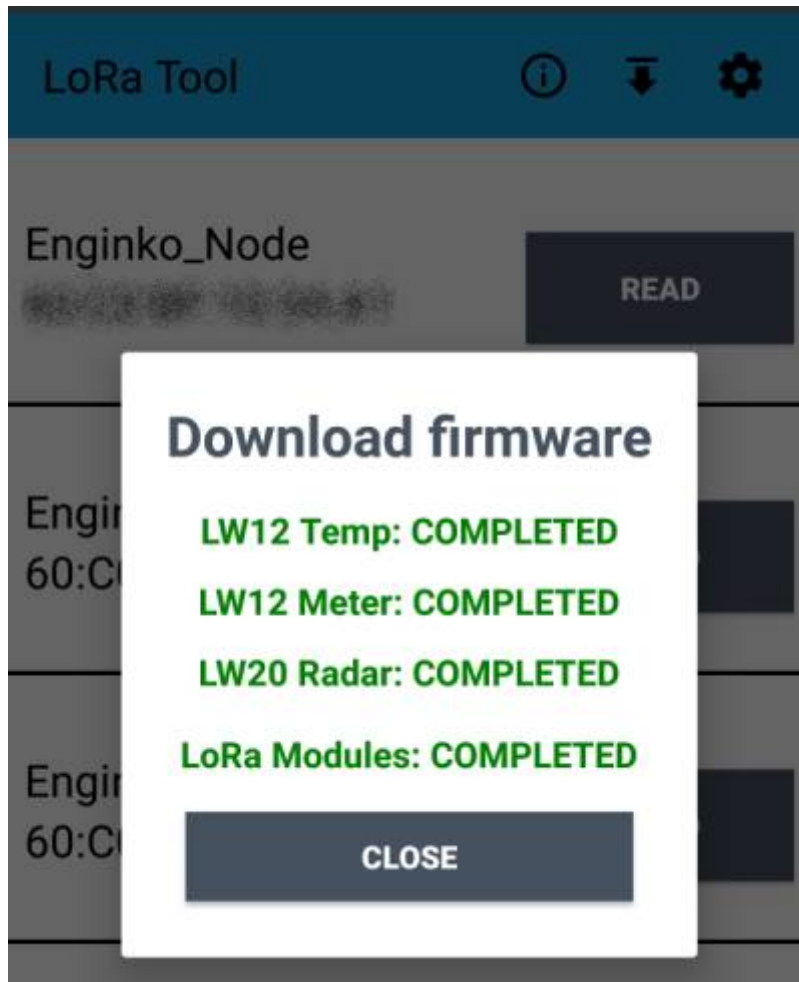

Update the sensor with LoRaTool:



During the update, do not move the smartphone until the end message.

3. Measures

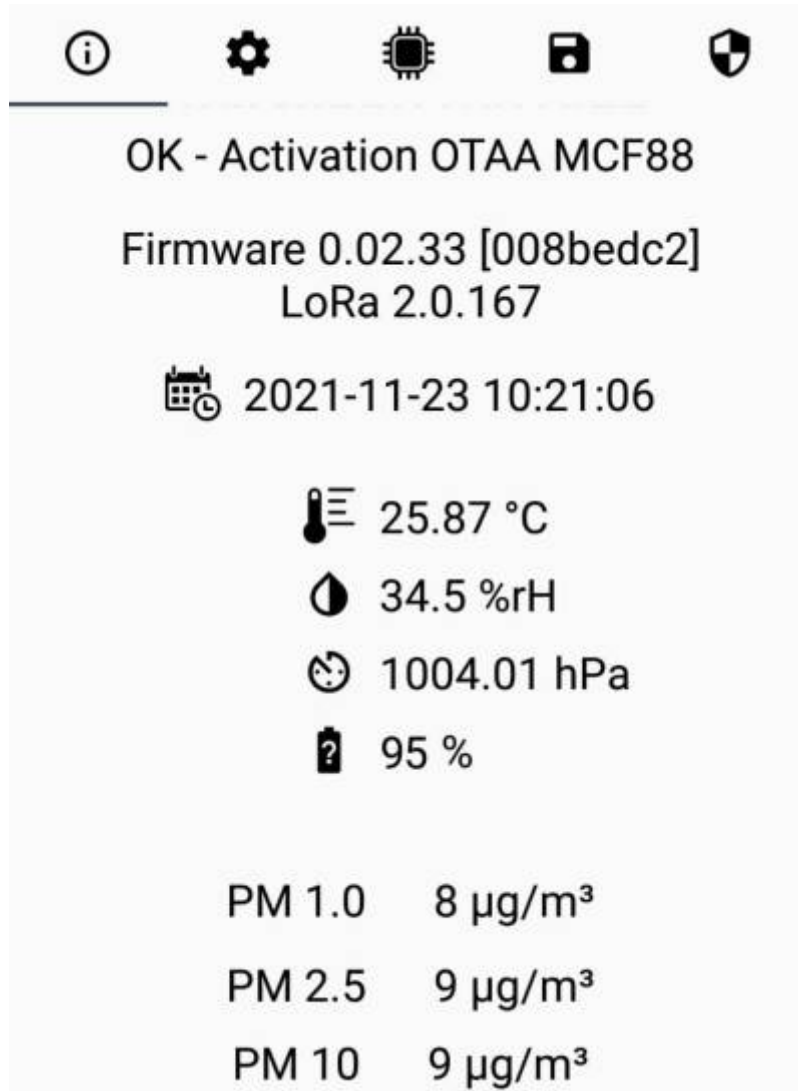

3.1 Period

Period is the interval (in minutes) between one measure and the next one. The sensor sends one measures for every transmission. Value can be between 15 and 65535 minutes (default: 30 minutes).

Period interval can be set with App or with downlink command.

3.2 Temperature

3.3 Pressure

3.3.1 Altitude compensation

When the sensor is not installed at the sea level, the reading of barometric pressures at other elevations must be compensated. Set the right altitude value with LoRa Tool app:

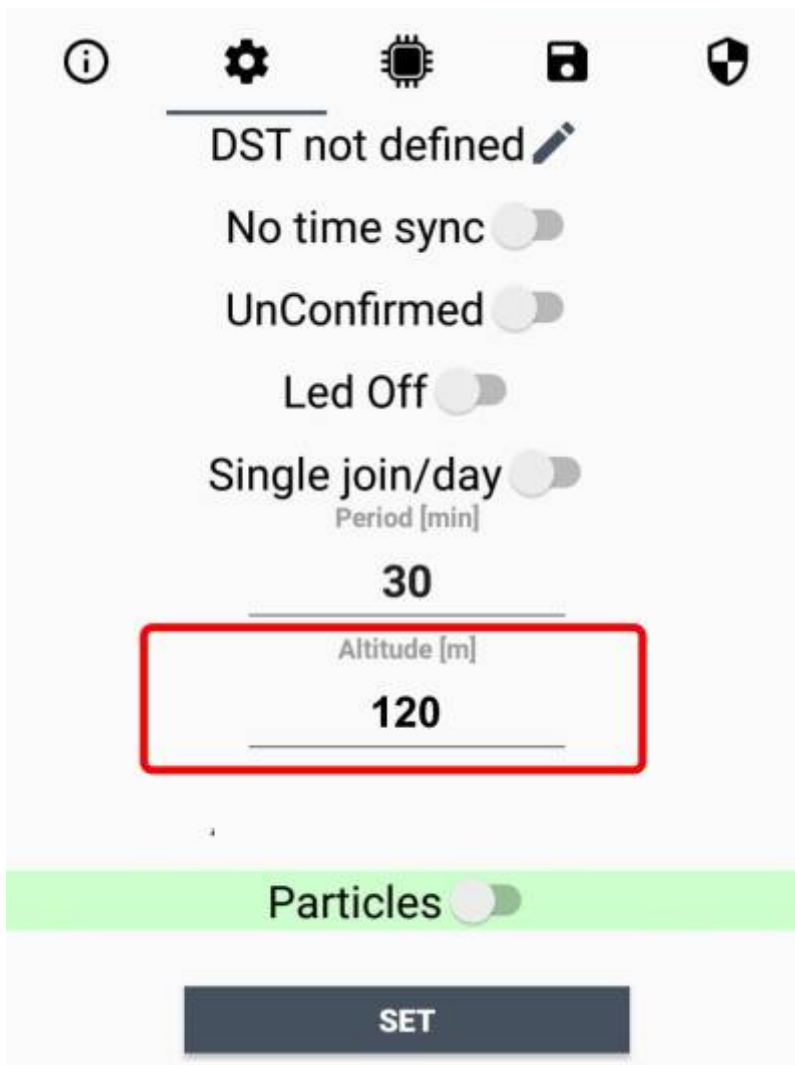

Value can be from -300 to 3000 meters.

Altitude can also be set with downlink command.

3.4 Humidity

3.5 PM

The PM measurement principle is based on laser scattering. This technology, together with high-quality and long-lasting components, enables precise measurements from its first operation and throughout its lifetime of more than ten years

3.5.1 Mass concentration/particles number

As default particulate matter is expressed as mass concentration (in $\mu\text{g}/\text{m}^3$). If "Particles" is set to ON, particulate matter is expressed as number concentration (in $\#/ \text{cm}^3$):

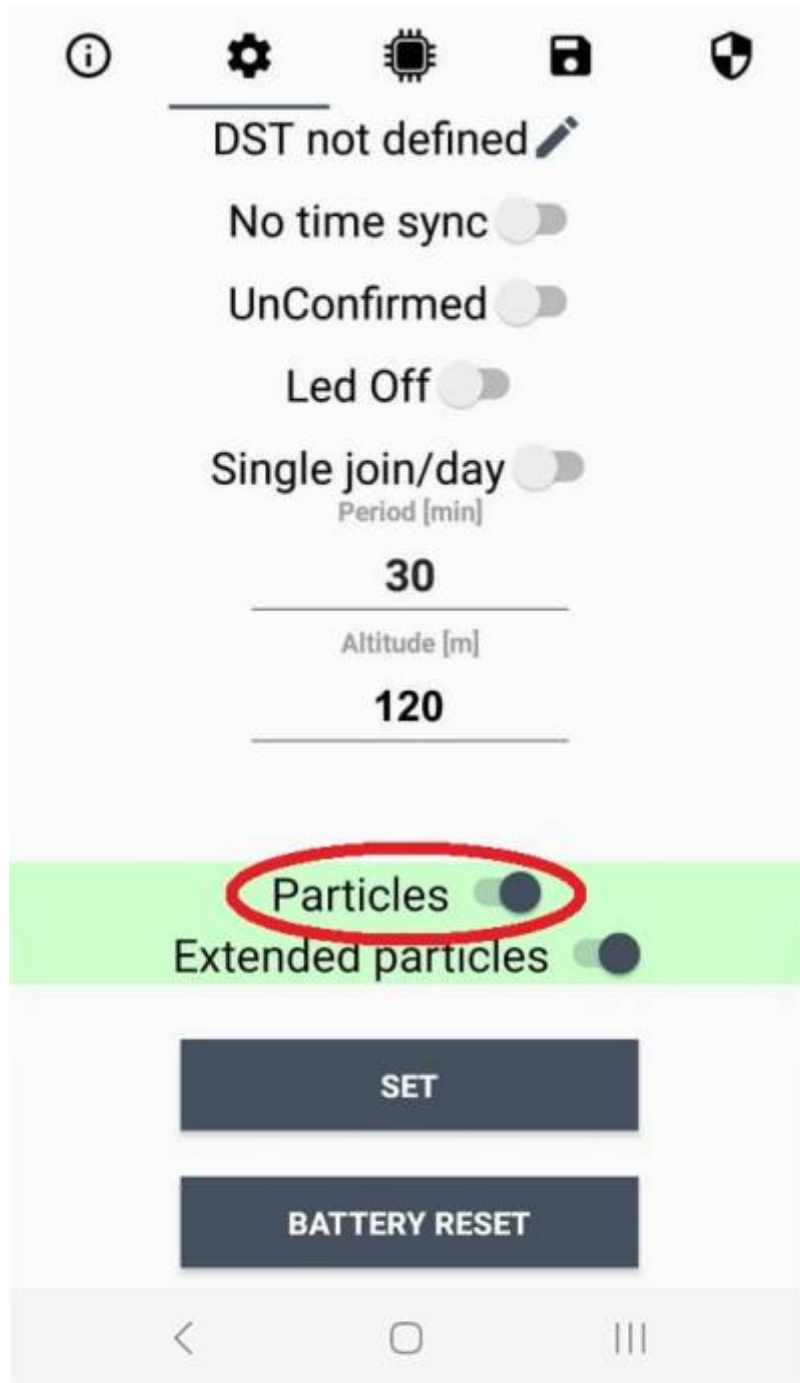

4 LoRaWAN network

The sensor is compliant with LoRaWAN® **specification 1.0.2, regional 1.0.2b.**



4.1 Activation

The device supports the following activations on a LoRaWAN® network:

- 1. **NONE**: sensor not activated
- 2. **OTAA**: the JoinEUI and the AppKey not setted, must be written to the device;
- 3. **OTAA MCF88**: Over the air activation, fixed keys: JoinEUI = 904e915000000001, AppKey on request;
- 4. **OTAA ENGINKO**: Over the air activation, fixed keys: JoinEUI = 904e915000000001, AppKey on request;
- 5. **ABP**: requires writing to the device of NwkSkey, AppSkey, DevAddr.



The device exits factory activated with **OTAA ENGINKO** mode. On request devices can be shipped already activated.

Note: in **OTAA** AppKey is write only, in reading the field will always be empty, even if set.

4.2 Other settings

Network settings:

please keep "Any" settings. Change it only if Objenious network is used (default_ any).

Network type:

LoRa syncword can be setted as "private"(0x12) instead "public" (0x34), but the NS must be setted accordingly (default: public).

Band:

select the right LoRaWAN ® band settings accodngly to country requirements.

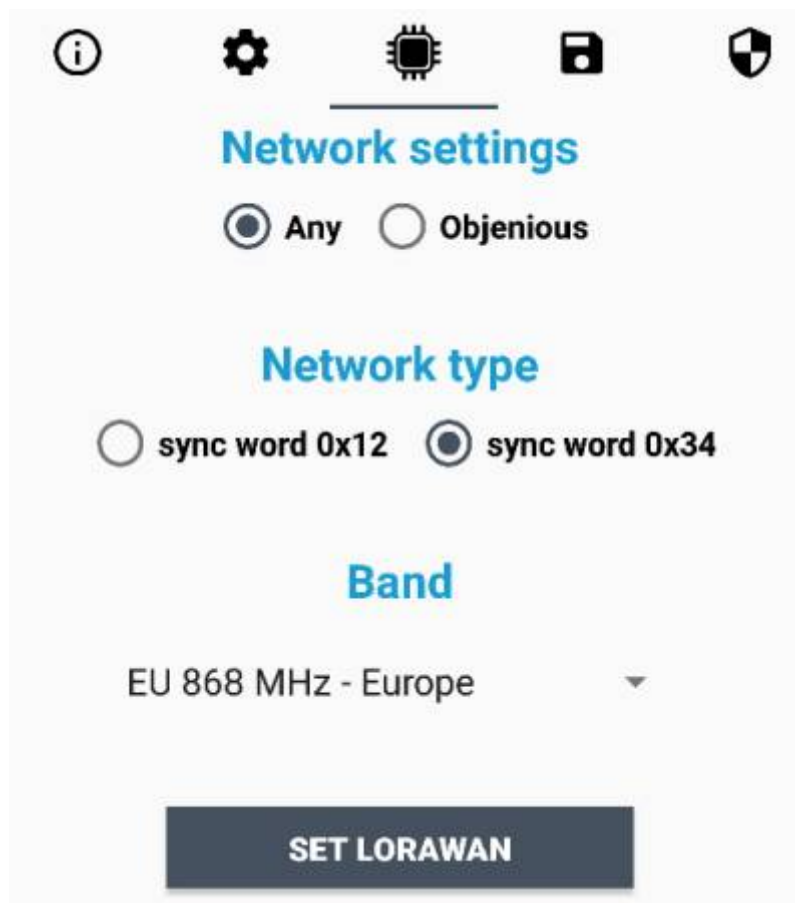

DST:

set to change DST (default: none).

No time sync:

set to disable time synchronization request (default: enabled).



Normally sensor asks for a time sync at every power on (uplink starting with 01) or, if enabled, once a week.

If not handled in the right way can cause a unnecessary battery consumption.

Please check chapter 2.1 [DATA FRAME FORMAT](#).

UnConfirmed:

set for unconfirmed uplinks (default: confirmed uplink).

Single join/day:

set for to allow only one join per day (default: multiple join allowed).

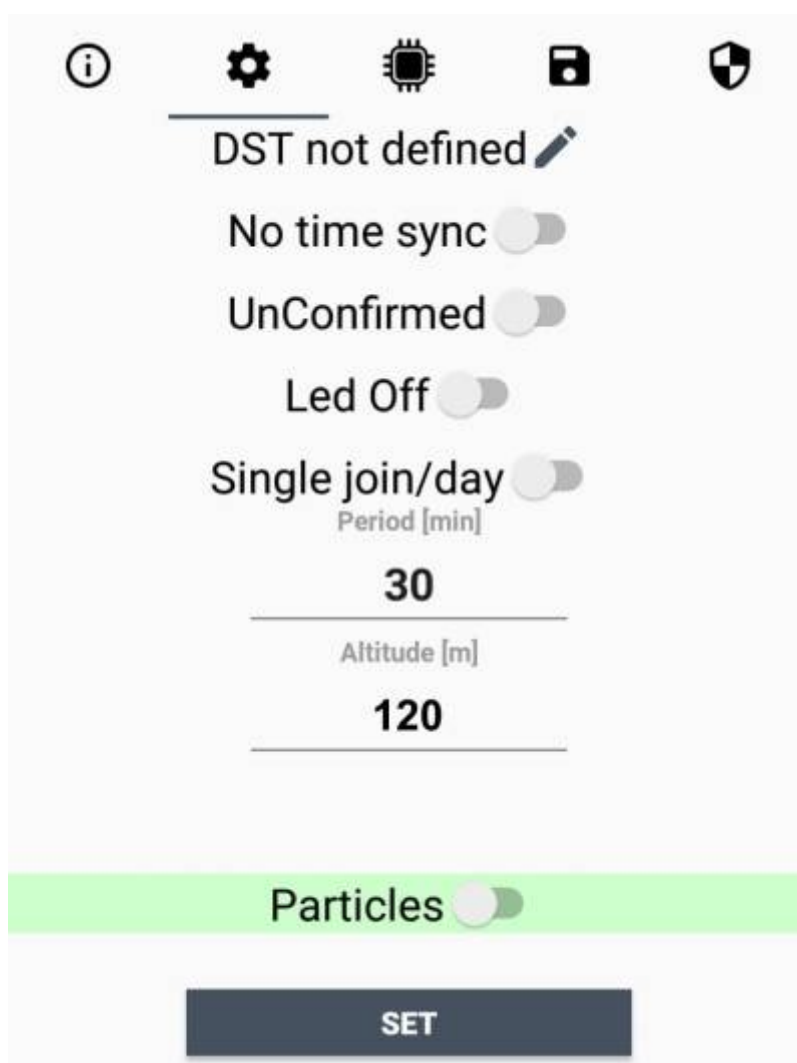

5 Passwords

The device can be protected by passwords, to avoid unauthorized persons to read data or modify parameters.

As default passwords are equal to 0.

Allowed values range from 0 to 999999999 (only numbers).

To change the passwords, set the new values with the LoRa Tool App:

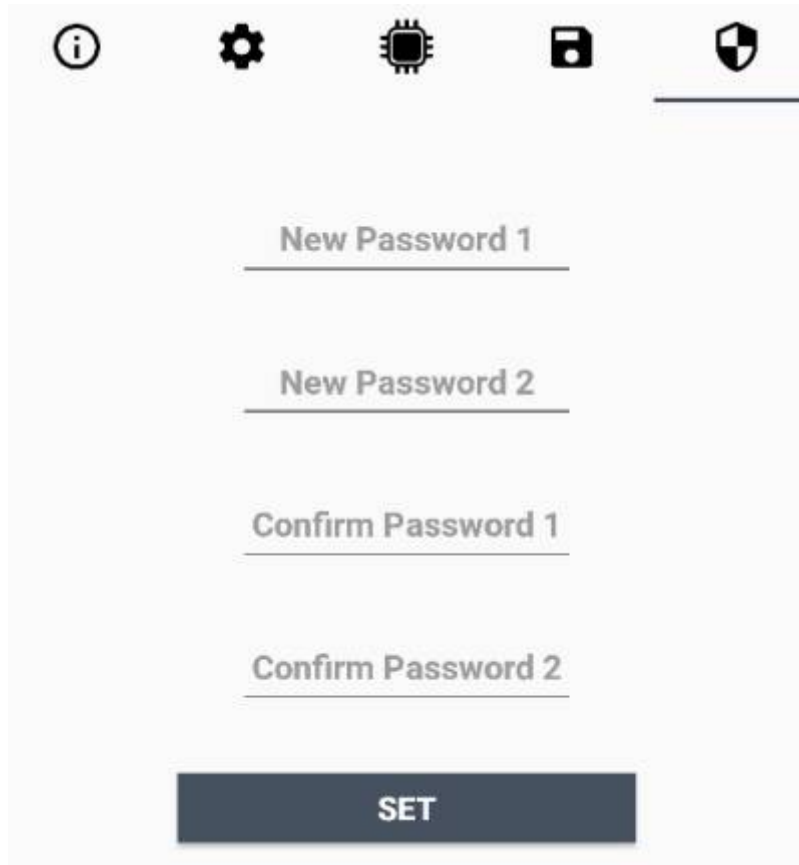

Once the passwords are setted, to gain access from LoRa Tool to the sensor, open the App:

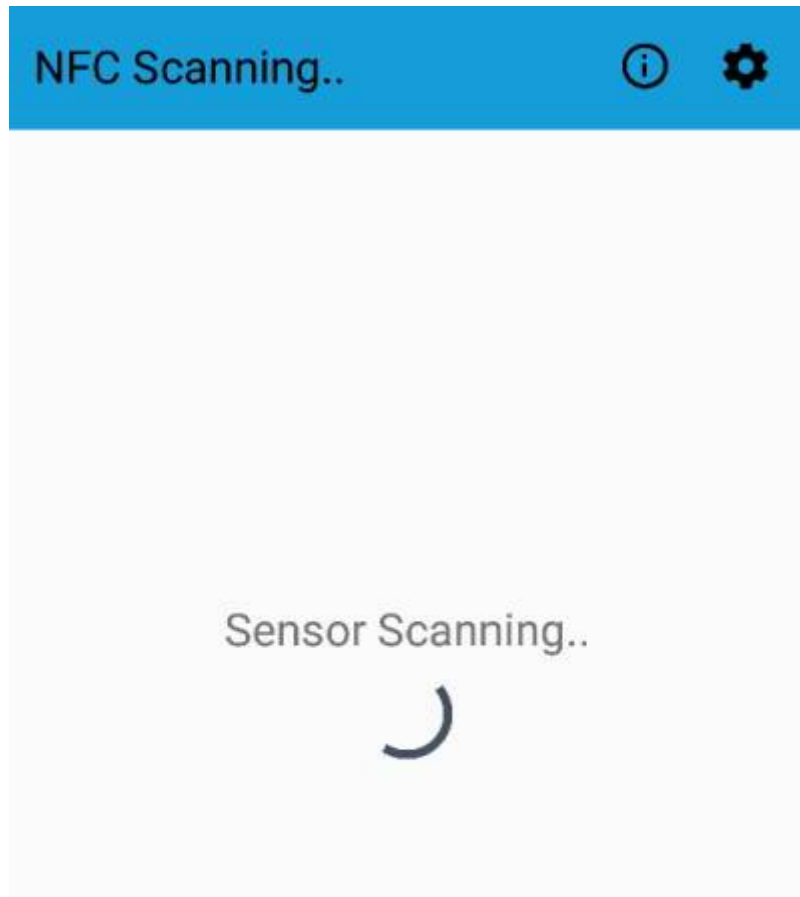

and set the right values before reading from the device:

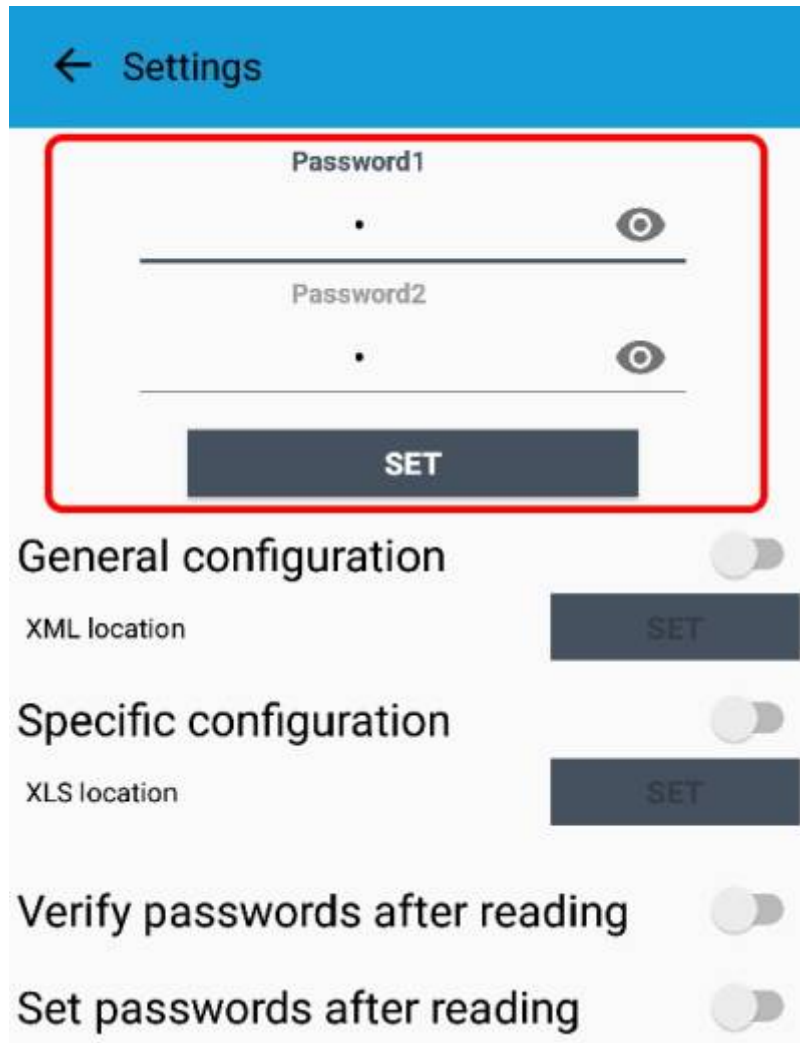

To bring back the sensor to factory default and reset the passwords, a reset code must be requested to Angel4Future (please provide the DevEUI of the sensor when you ask for that code).

6 Configuration file

With LoRa Tool App is possible to configure the device using an XML file, instead to manually adjust the parameters (for details about the file format please ask to Angel4Future). This is very useful especially in case of multiple devices configuration.

With "Save" button an XML file with the actual configuration of the sensor will be generated. This is useful to store or clone the configuration, or to send it to Angel4Future's support if needed.



6.1 Multi devices configuration

With LoRa Tool App is possible to configure many devices in an easy way.

For multi-configuration is needed at least one XML file with the parameters to set.

Settings on this file will be applied to all the sensors.

With an additional XLS file is possible to load different LoRa configuration parameters (Activation Type, AppKey, AppEUI, NetKey, DevAddress, Band, Private option) for each sensor, based on DevEUI.

When the sensor is approached, if one parameter is different from files, the APP will ask you if you want to overwrite.

XLS is prevailing on the XML, so if both files are enabled, if the DevEUI of the device matches one of the DevEUIs in the XLS file, LoRa parameters will be setted from this one.

These configuration can be done in the in the Settings:

- Enable or disable the use of the general configuration by file;
- Enable or disable the use of the specific configuration by file;
- Verify the passwords;
- Writing the passwords.

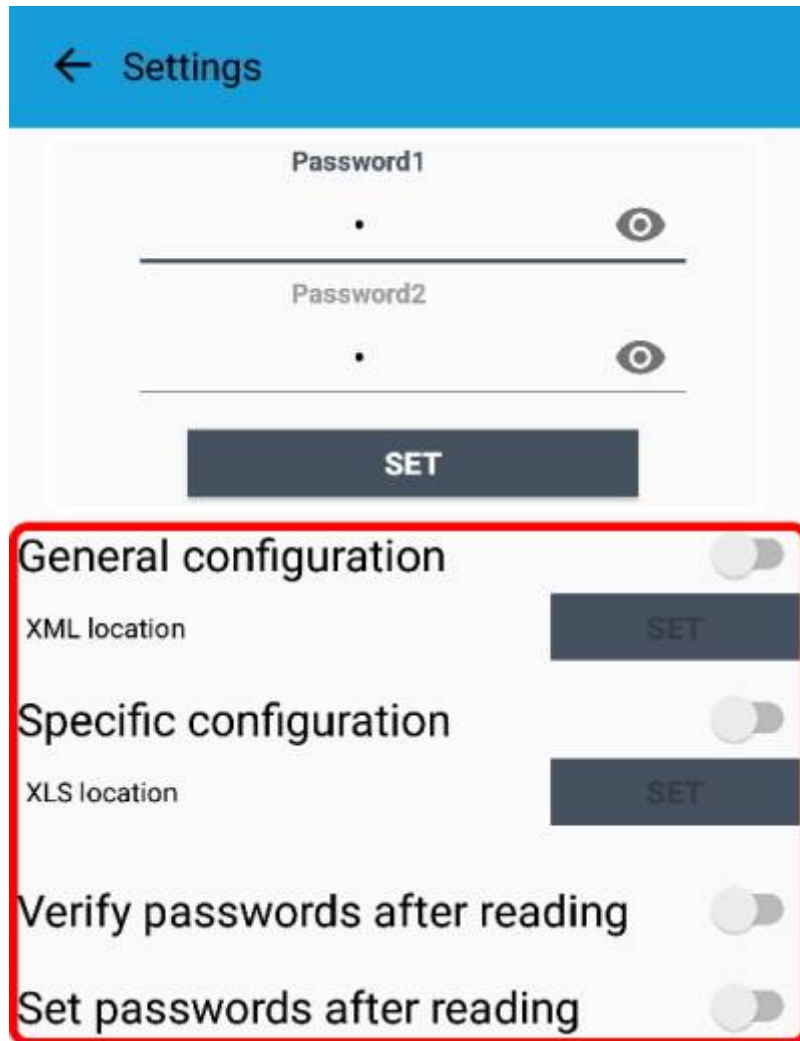

For details on files format please ask to Angel4Future.

7 LoRaWEB Tool

Angel4Future provides free **LoRaWEB** online tool, where for each sensor it is possible to find documentation, javascript examples for parsing, downlink generator and uplink decoder:

[LoRaWEB Tool](http://iot.mcf88.cloud/LoRaWeb) (iot.mcf88.cloud/LoRaWeb)



8 Payload

For payload descriptions, uplinks and downlinks format and available commands please refer to this document:

[DATA FRAME FORMAT](#)

9 Maintenance

Keep the surfaces clean and remove dust from the solar panel with a damp cloth when necessary.

Gently remove any debris, bugs or cobwebs lodged inside the unit. Perform these operations regularly (every 6 months).

10 Ordering code

Code	Description
MCF-LW12TERPM	enginko LoRaWAN® outdoor PM and environmental sensor EU863-870
MCF-LW12TERPM-AS	enginko LoRaWAN® outdoor PM and environmental sensor AS920-925
MCF-LW12TERPM-US	enginko LoRaWAN® outdoor PM and environmental sensor US902-928
MCF-LW12TERPM-AU	enginko LoRaWAN® outdoor PM and environmental sensor AU915-928

11 Declaration of conformity

Hereby, enginko Srl declares that MCF-LW12TERPM complies with the essential requirements and other relevant provisions of Directive 2014/53/EU.

12 Contacts

Angel4Future S.r.l.

Via San Sabino 21 - 70042 MOLA DI BARI (BA) , ITALY

T : +39 080 532 1796

E : info@angel4future.com

W: enginko.com

From:

<https://enginko.com/support/> - **enginko.support.center**

Permanent link:

https://enginko.com/support/doku.php?id=manual_mcf-lw12terpm&rev=1740731439

Last update: **2025/02/28 09:30**

