

Table of Contents

- MCF-LW12MET Operating Manual** 1
- 1. Description** 1
- 2. Overview** 2
 - 2.1 Technical data 2
 - 2.2 Installation 2
 - 2.3 Power supply 3
 - 2.4 Configuration 4
 - 2.5 System leds 5
 - 2.6 Firmware update 5
- 3. Measures** 8
- 4 I/O** 10
 - 4.1 Input 11
 - 4.2 Output 12
 - 4.3 Wiring examples 12
- 4 LoRaWAN® network** 14
 - 5.1 Activation 14
 - 5.2 Other settings 15
- 6 Passwords** 19
- 7 Configuration file** 21
 - 7.1 Multi devices configuration 22
- 8 LoRaWEB Tool** 23
- 9 Payload** 24
- 10 Ordering code** 24
- 11 Declaration of conformity** 24
- 12 Contacts** 24



MCF-LW12MET Operating Manual

Important safety information



Read this manual before attempting to install the device! Failure to observe recommendations included in this manual may be dangerous or cause a violation of the law. The manufacturer will not be held responsible for any loss or damage resulting from not following the instructions of this operating manual.

- Do not dismantle or modify in any way.
- Avoid mechanical stress
- The device is not intended to be used as a reference sensor, and enginko Srl will not be held liable for any damage which may result from inaccurate readings.
- Do not use any detergent or alcohol to clean the device.
- Do not mount in horizontal position.

Disposal information for users



Pursuant to and in accordance with Article 14 of the Directive 2012/19/EU of the European Parliament on waste electrical and electronic equipment (WEEE).

The barred symbol of the rubbish bin shown on the equipment indicates that, at the end of its useful life, the product must be collected separately from other waste.

1. Description

The MCF-LW12MET is a LoRaWAN® metering that allows instantaneous reading of active, reactive and apparent power, voltage and current up to 230Vac - 16Amp (active, reactive and apparent energy, Class 0.2s). It can switch ON and OFF a 230 Vac - 8A load and reads the status of a 100-230 Vac input. It can be used for industrial process control and home automation, energy metering, water treatment, agriculture irrigation and similar applications. Input can be used as pulse counter.



2. Overview

2.1 Technical data

- CPU Cortex M0+
- EEPROM 32KB
- Flash 64KB
- Real time clock
- Encryption AES 128 bit
- Class C LoRaWAN® stack EU868, AS923, AU915, US915
- Transmission band (EU version): 868 MHz
- Transmission Power (EU version): 14dBm max
- Power supply 100÷240Vac~ 50/60 Hz
- Metering of a 230Vac - 16Amp Load (active, reactive and apparent energy, Class 0.2s)
- Configurable default power-on status
- Instantaneous reading of active, reactive and apparent power, voltage and current
- Time interval based or thresholds based uplink
- Remote configuration
- Power consumption 1W
- 1 opto-isolated input, 230Vac
- 1 relay output with COM, NO, NC contacts, 8A@230Vac~
- NFC for node setup and FW upgrade
- Bicolor led (green, blue), for output and LoRaWAN® status
- Overload protection
- Embedded antenna
- Storage temperature range -20°C ÷ +80°C
- Working temperature range -10°C ÷ +70°C
- Dimension: 87.2x53.4x25mm



2.2 Installation

The installation has to be done by a qualified electrician.

The device is intended as subassembly (component).

It is responsibility of the assembler of equipment incorporating to ensure that the overall equipment is safe.

The MCF-LW12MET must be mounted in vertical position.

Please refer to following connections:

Name	Description
L LINE	Device power supply: 110÷230Vac~ Live
N LINE	Device power supply: 110÷230Vac~ Neutral
L LOAD	110÷230Vac~ Live to Load
N LOAD	110÷230Vac~ Neutral to Load
L IN	Digital Input monitor: 110÷230Vac~ Live
N IN	Digital Input monitor: 110÷230Vac~ Neutral
C	Terminal for Common contact
NC	Terminal for Normally Close contact
NO	Terminal for Normally Open contact

The device must be placed where the LoRaWAN® signal coverage is good (SF = 7 optimal, SF = 12 weak).

2.3 Power supply

Connect the power supply to pins L LINE and N LINE. Valid range is 100Vac~ to 240Vac~ 50/60Hz.



2.4 Configuration

To deploy the sensor, download the latest **LoRa Tool** Android App to setup LoRaWAN® credentials and other preferences :



Move the NFC antenna of the mobile (the exact position varies depending on the model of the smartphone) to the sensor antenna, in the area shown in the figure:









To use the NFC interface, the device must be powered through terminals L LINE and N LINE. The power status is visible on the red/green led.

Always validate your settings by reading the NFC data after the sensor has restarted.

Configuration can be done only via NFC. No USB port available.

2.5 System leds

LoRaWAN® not configured		Slow flashing
Joining		Quick flashing
Sending		Quick flashing
Receiving		Quick flashing
Steady state		Fixed
Data error		Flashing 2 seconds
Connection error		Flashing 1 second

2.6 Firmware update

Download the latest firmwares available on the smartphone with LoRaTool app:





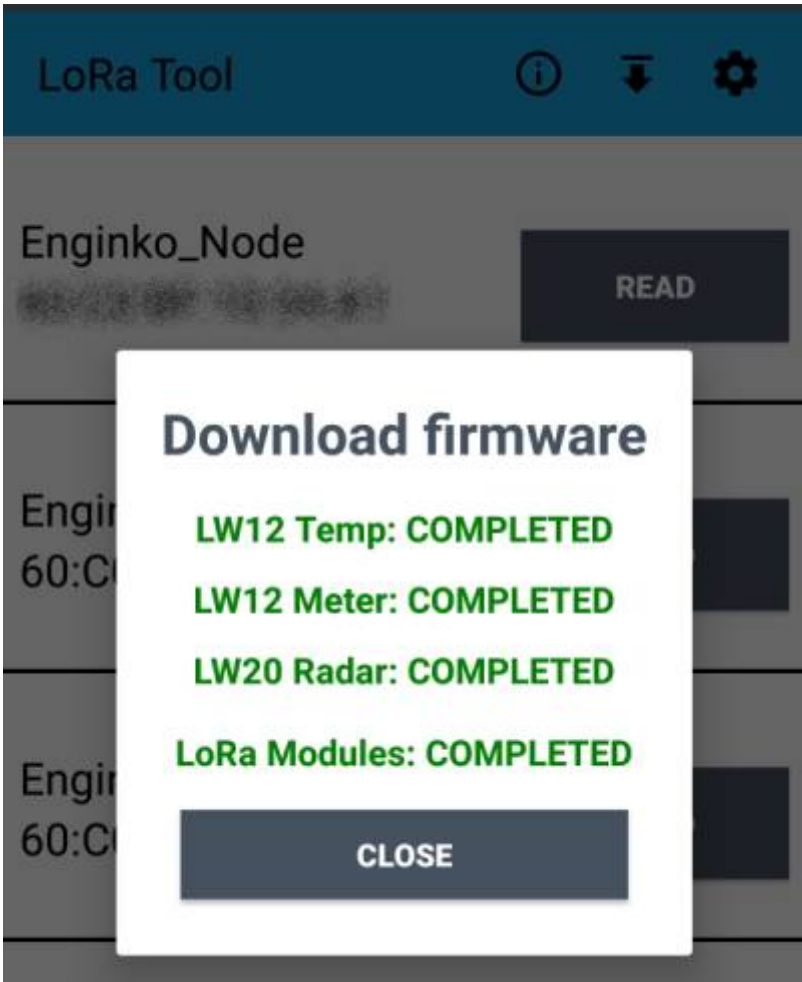

Update the sensor with LoRaTool:



During the update, do not move the smartphone until the end message.

3. Measures

On each reading of the sensor by LoRaTool, the measures are shown on the main page:



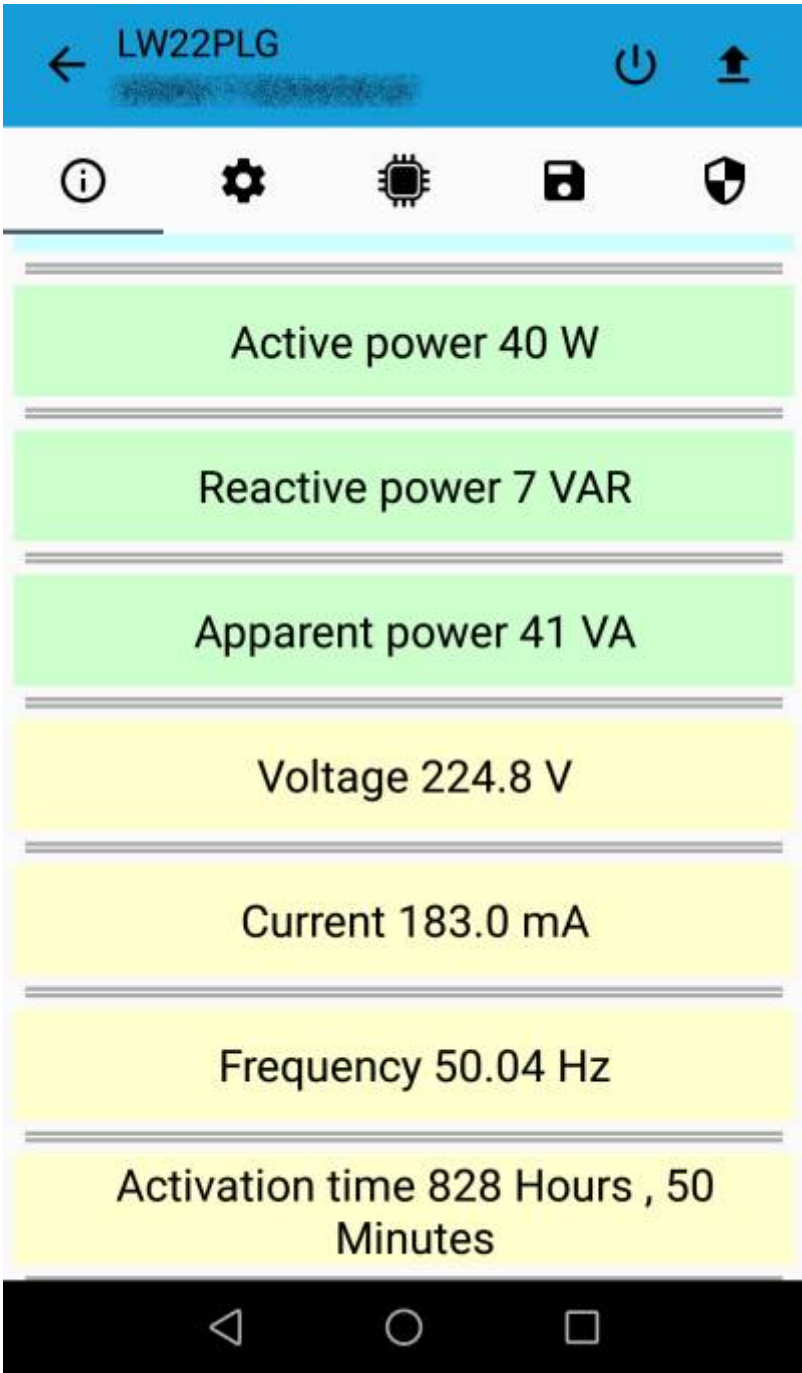

Once provisioned on a LoRaWAN® network, the device sends the measures to the server via uplink.

4 I/O

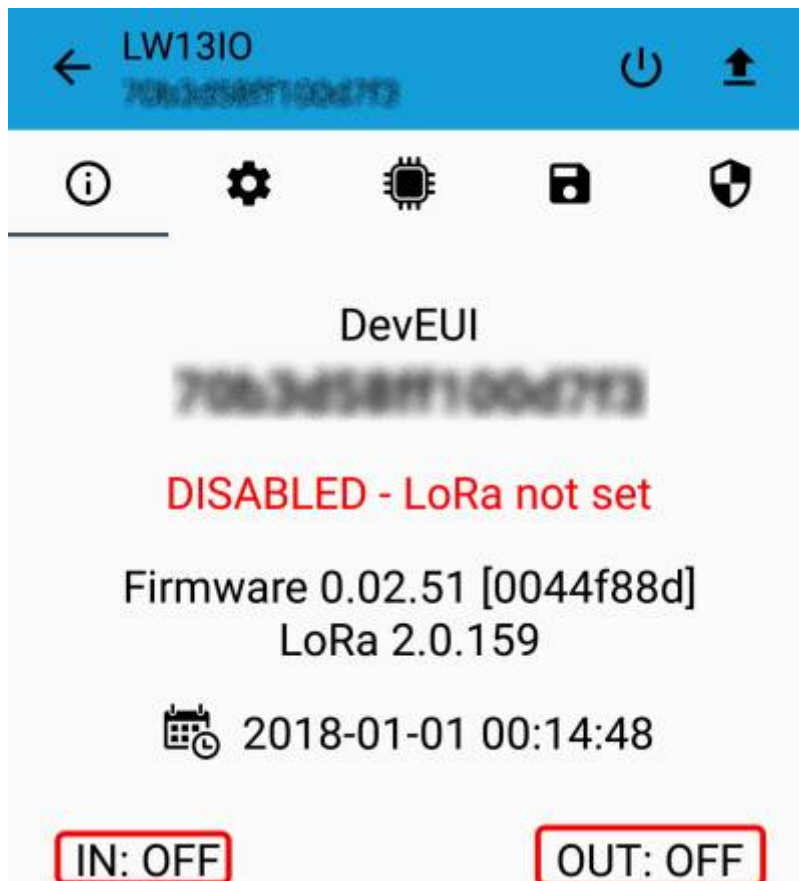

As default, the device sends a message every time an input or an output changes.

A downlink with new output status forces the device to send back an unblink with the new status. If the output status is the same of current one, the sensor will not send back any message.

Downlink examples (hex):

turn ON the output:	0400 0 1 00 0000 0000 0000
turn off the output:	0400 0000 0000 0 1 00 0000
receive the current status:	0400 0000 0000 0000 0000

Is possible to set a period (in minutes) to receive a recurrent periodic message with the I/O status.

4.1 Input

Off voltage	0÷2Vac 50/60Hz
On Voltage	> 8Vac 50/60Hz
Maximum input voltage	250Vac 50/60Hz
Input current	3mA typ
Max frequency (as counter)	2 Hz
Optoinsulation	NONE

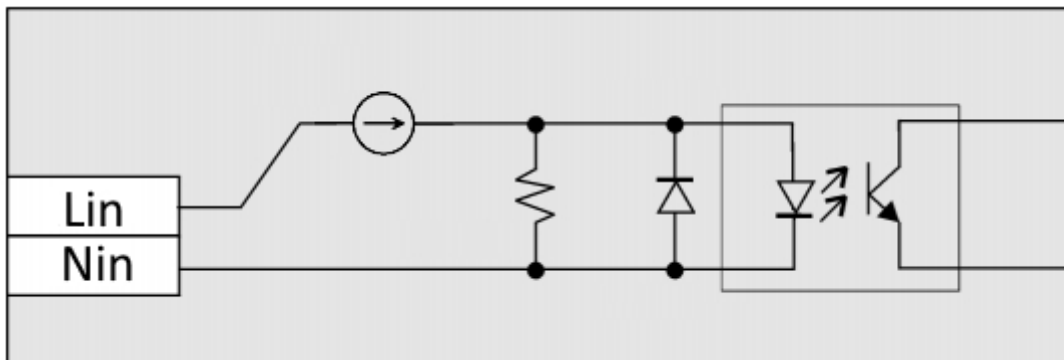

Caution: NIN and NLINE are internally connected.

Input can be used as pulse counters (see settings chapter).

4.2 Output

Contact mode	SPDT
Max. power commutable	2000VA
Maximum switching voltage	250Vac~
Max. current	8A

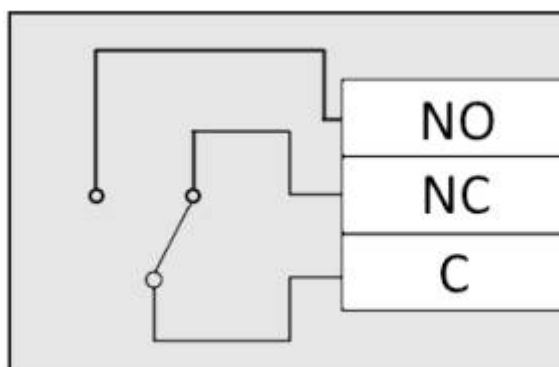

The output has pulse capability (minimum pulse duration is 100ms, maximum around 100 minutes), so, instead to send two different commands (one to turn on and one to turn off the output), is possible to send a duration command, for example to drive valves or heaters

As application example, to safely turn on an output, send a ON-pulse command for a defined time (for example, for the maximum allowed interval), and before the expiring time, another ON-pulse command if the output still needs to be ON, or a simply OFF command if you want to turn it off.

CALENDAR*

4.3 Wiring examples

Load connected to the same supply of the sensor, connected to the relay output (normally open contact) and digital input driven by a switch:



Energy monitoring of a load connected to the same supply of the sensor:



Energy monitoring of a load connected to the same supply of the sensor driven by the relay (normally open contact):

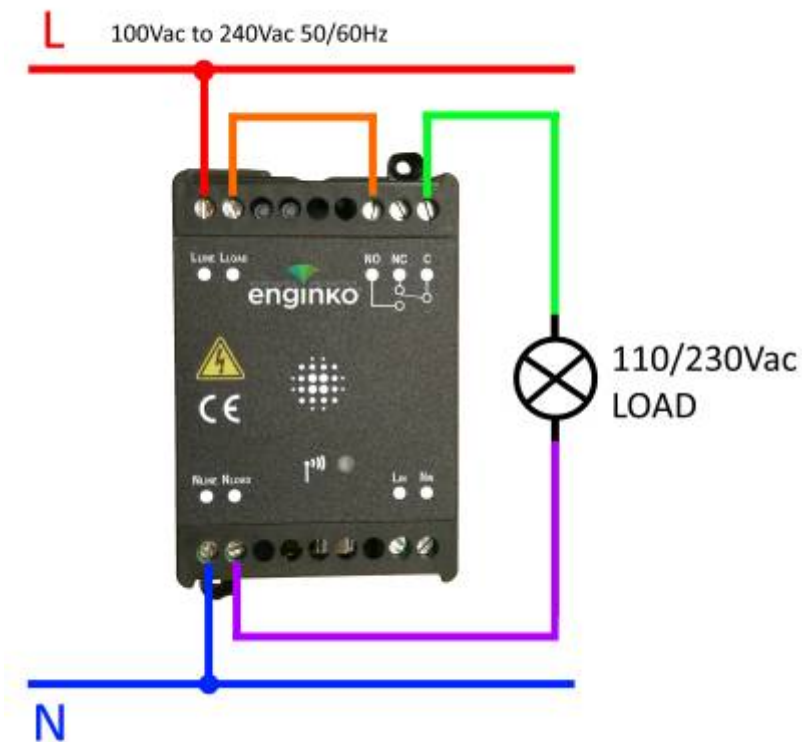

4 LoRaWAN® network

The sensor is compliant with LoRaWAN® **specification 1.0.2, regional 1.0.2b.**



5.1 Activation

The device supports the following activations on a LoRaWAN® network:

1. **NONE**: sensor not activated
2. **OTAA**: the JoinEUI and the AppKey not setted, must be written to the device;
3. **OTAA MCF88**: Over the air activation, fixed keys: JoinEUI = 904e915000000003, AppKey on request;
4. **OTAA ENGINKO**: Over the air activation, fixed keys: JoinEUI = 904e915000000003, AppKey on request;
5. **ABP**: requires writing to the device of NwkSkey, AppSkey, DevAddr.



The device exits factory activated with **NONE** mode. On request devices can be shipped already activated.

Note: in **OTAA** AppKey is write only, in reading the field will always be empty, even if set.

5.2 Other settings

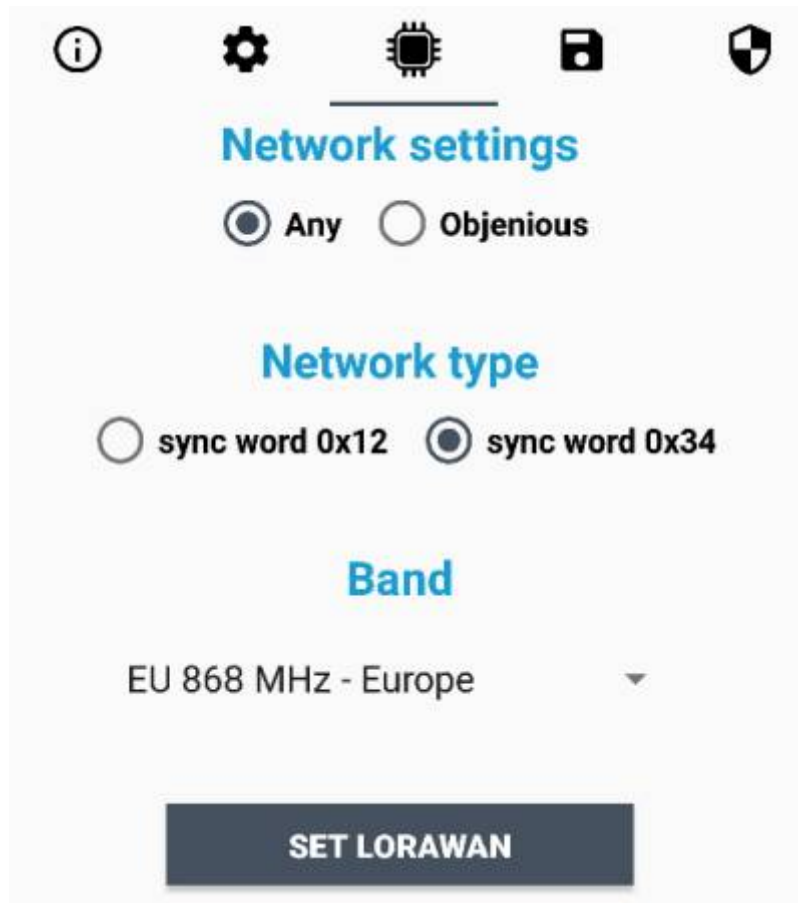

Network settings:

please keep "Any" settings. Change it only if Objenious network is used (default_ any).

Network type:

LoRa syncword can be setted as "private"(0x12) instead "public" (0x34), but the NS must be setted accordingly (default: public).

Band:

select the right LoRaWAN ® band settings accodingly to country requirements.

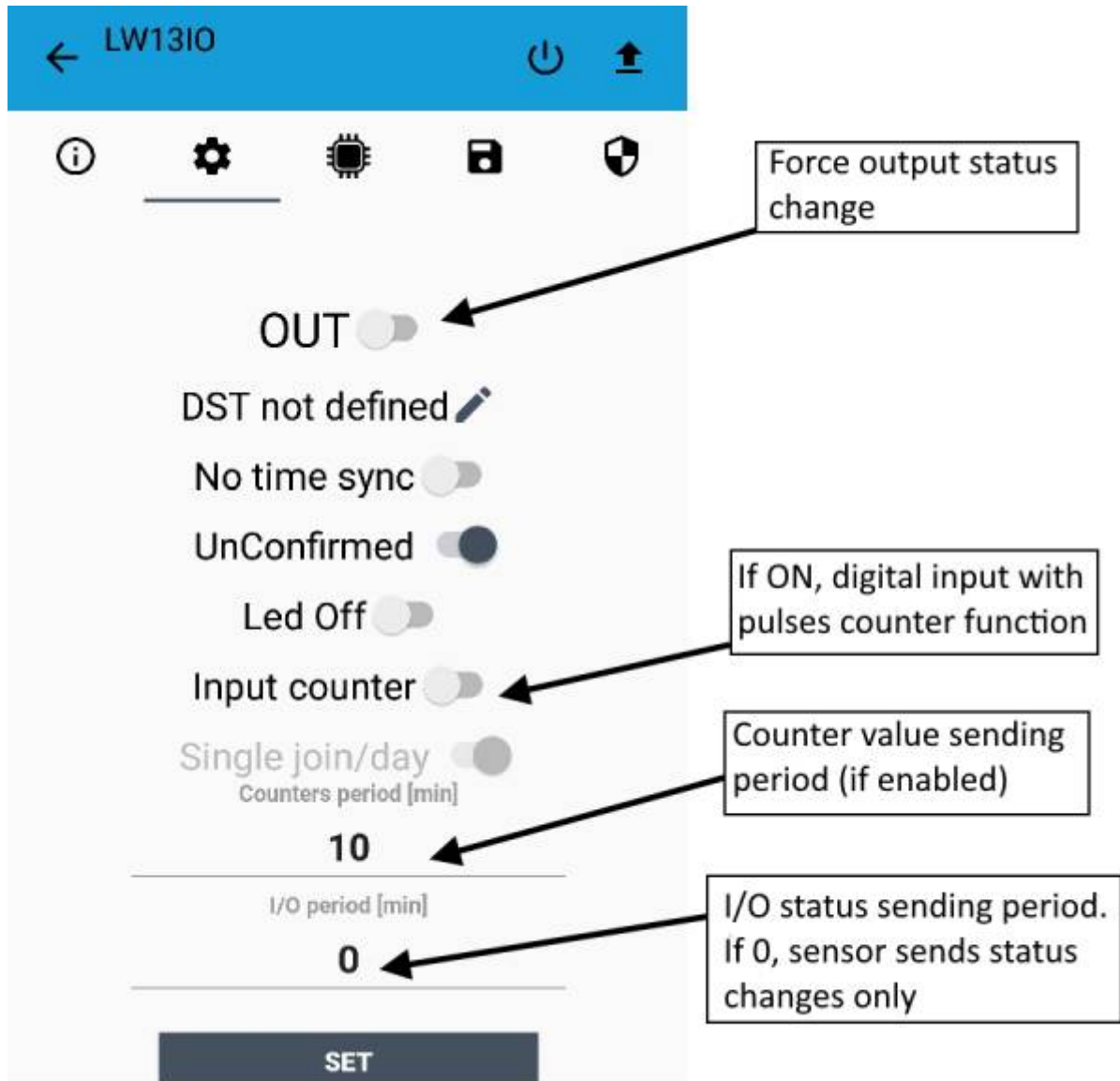

OUT:
set to force a change of the output (default: off).

DST:
set to change DST (default: none).

No time sync:
set to disable time synchronization request (default: enabled).



Normally sensor asks for a time sync at every power on (uplink starting with 01) or, if enabled, once a week.

Please check chapter 2.1 [DATA FRAME FORMAT](#).

UnConfirmed:

set for unconfirmed uplinks (default: confirmed uplink).

Led Off:

set to disable the system leds (default: enabled).

Input counter:

set to enable the pulses counter funcion (default: disabled).

Single join/day:

set for to allow only one join per day (default: multiple join allowed).

Counters period [min]:

if counter enabled, this is the interval (in minutes) between one measure and the next one. The sensor sends one measures for every transmission. Value can be between 1 and 255 minutes (default: 0 minutes). Period interval can be set with App or with downlink command.

I/O period [min]:

if different from 0, this is the interval (in minutes) between one I/O messages status and the next one. Value can be between 1 and 255 minutes (default: 0 minutes - disabled).

Period interval can be set with App or with downlink command.

Period:

time interval between two measures (in minutes).

Clock timed:

set to sincronize the reading with the internal clock (default: off).

230/120Vac:

set is line voltage is 120Vac (default: 230Vac).

Send all metering value:

set to send cumulative and istantaneous values (default = off).

5.2.1 Thresholds

Is possible to set 4 thresholds for the active power:

Th+ = Threshold High Rising

Th- = Threshold High Falling

TI+ = Threshold Low Rising

TI- = Threshold Low Falling

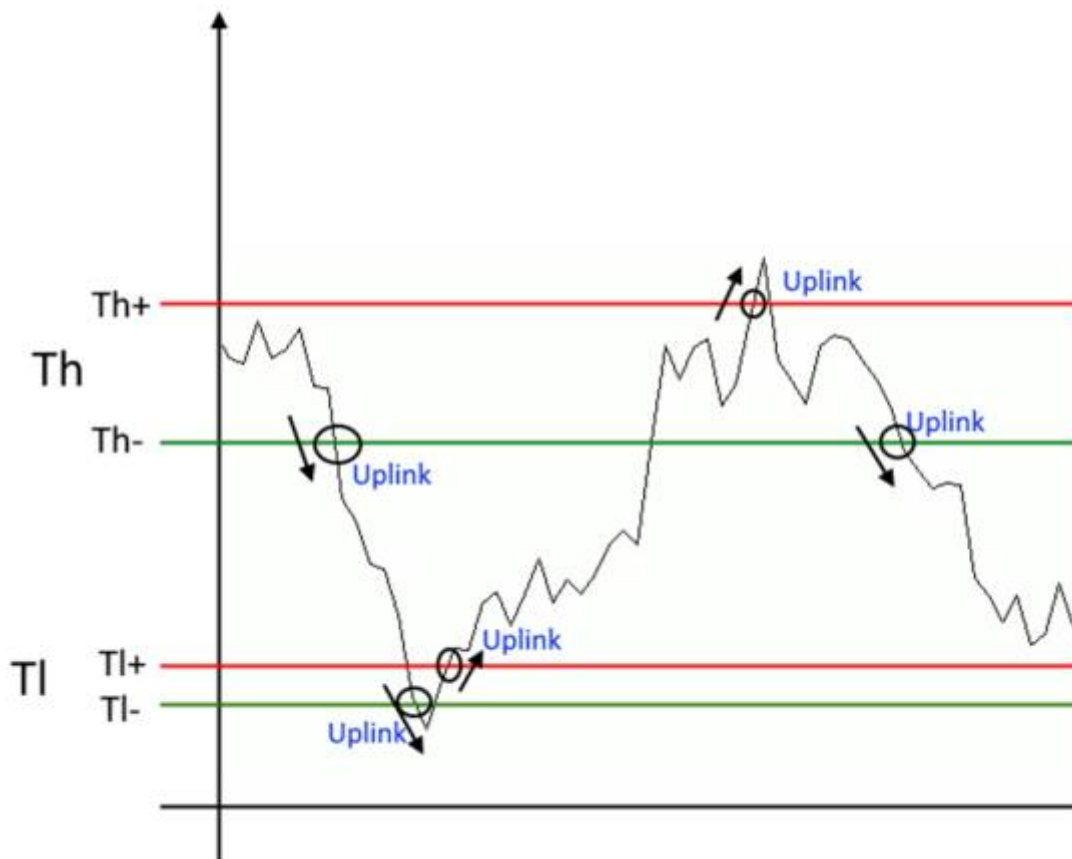

When target values are rising and exceed the positive thresholds, the device sends an uplink with the latest measure.

When values are falling below the negative thresholds, the device sends a new uplink with the latest measure.

Thresholds can be enabled, disabled and changed via LoRaTool or with downlinks.

6 Passwords

The device can be protected by passwords, to avoid unauthorized persons to read data or modify parameters.

As default passwords are equal to 0.

Allowed values range from 0 to 999999999 (only numbers).

To change the passwords, set the new values with the LoRa Tool App:

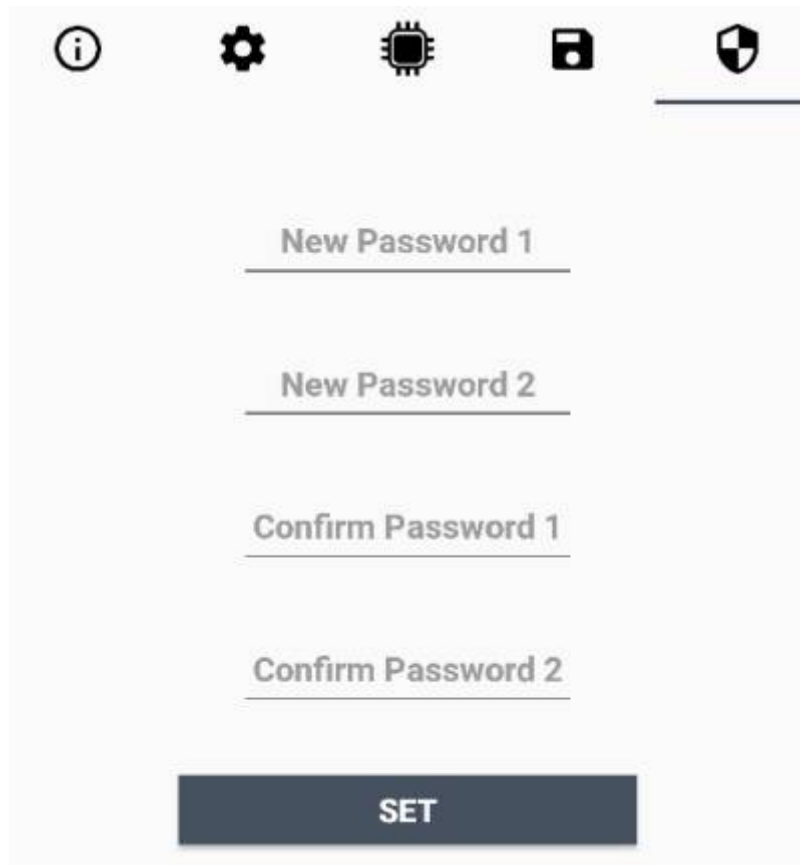

Once the passwords are setted, to gain access from LoRa Tool to the sensor, open the App:

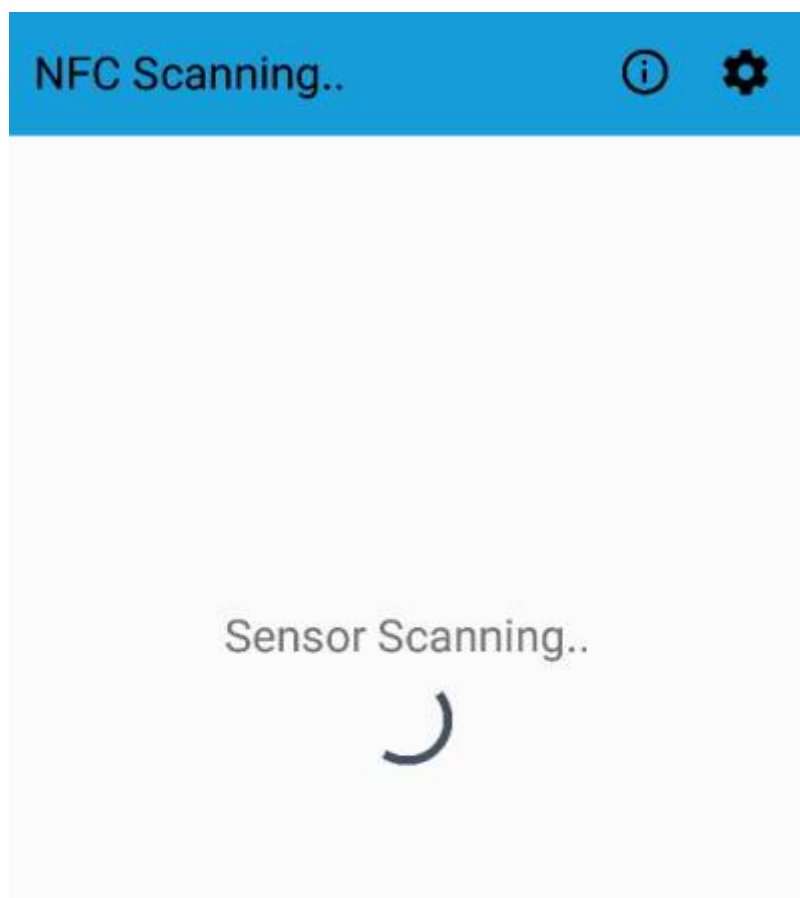

and set the right values before reading from the device:

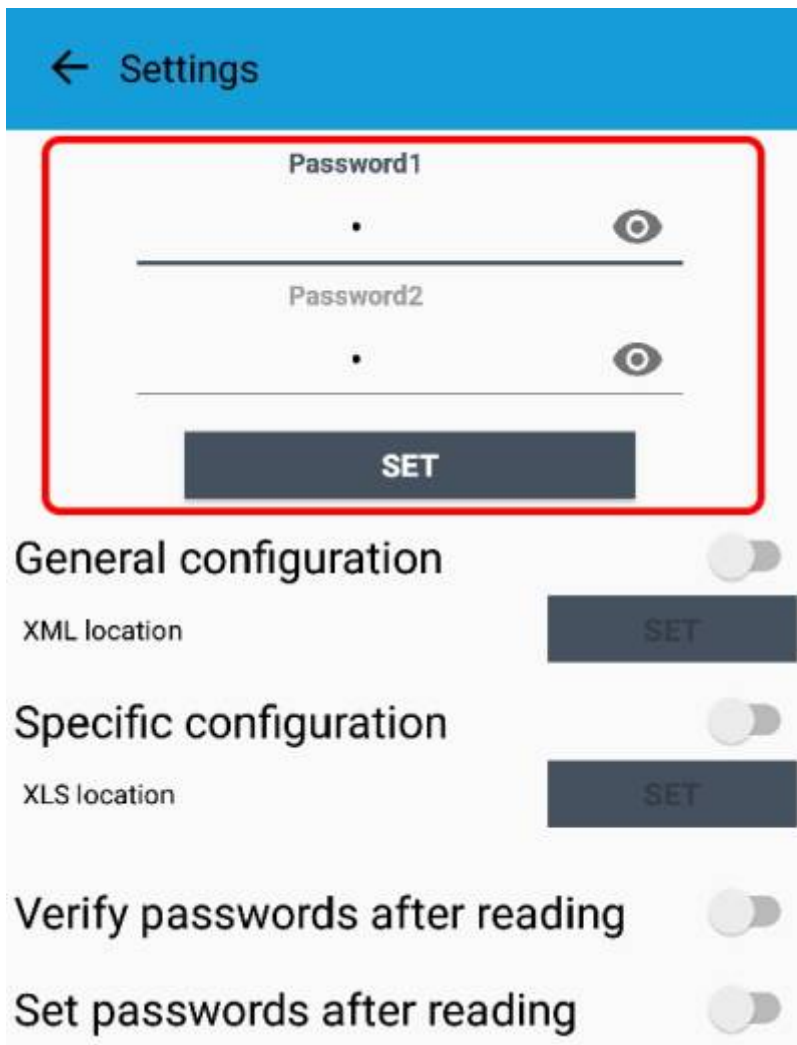

To bring back the sensor to factory default and reset the passwords, a reset code must be requested to enginko (please provide the DevEUI of the sensor when you ask for that code).

7 Configuration file

With LoRa Tool App is possible to configure the device using an XML file, instead to manually adjust the parameters (for details about the file format please ask to enginko). This is very useful especially in case of multiple devices configuration.

With “Save” button an XML file with the actual configuration of the sensor will be generated. This is useful to store or clone the configuration, or to send it to enginko's support if needed.



7.1 Multi devices configuration

With LoRa Tool App is possible to configure many devices in an easy way.

For multi-configuration is needed at least one XML file with the parameters to set.

Settings on this file will be applied to all the sensors.

With an additional XLS file is possible to load different LoRa configuration parameters (Activation Type, AppKey, AppEUI, NetKey, DevAddress, Band, Private option) for each sensor, based on DevEUI.

When the sensor is approached, if one parameter is different from files, the APP will ask you if you want to overwrite.

XLS is prevailing on the XML, so if both files are enabled, if the DevEUI of the device matches one of the DevEUIs in the XLS file, LoRa parameters will be setted from this one.

These configuration can be done in the in the Settings:

- Enable or disable the use of the general configuration by file;
- Enable or disable the use of the specific configuration by file;
- Verify the passwords;
- Writing the passwords.

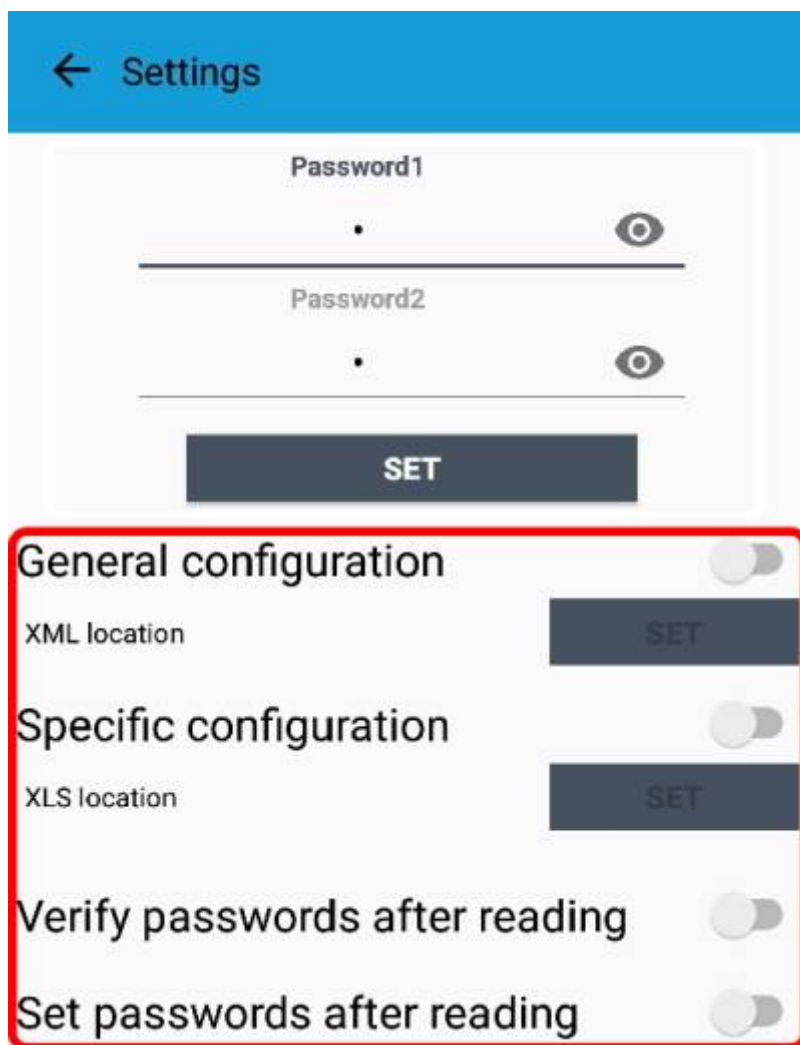

For details on files format please ask to enginko.

8 LoRaWEB Tool

enginko provides, upon free registration, **LoRaWEB** online tool, where for each sensor it is possible to find documentation, javascript examples for parsing, downlink generator and uplink decoder:

[LoRaWEB Tool](http://iot.mcf88.cloud/LoRaWeb) (iot.mcf88.cloud/LoRaWeb)

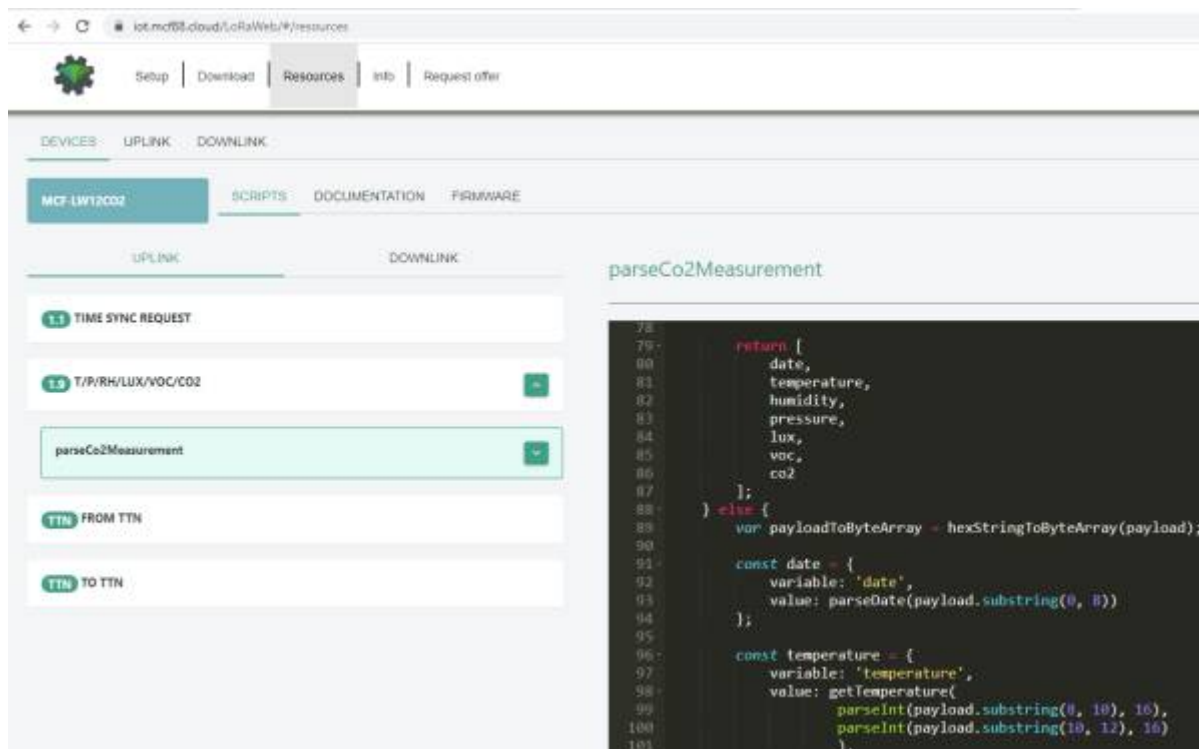
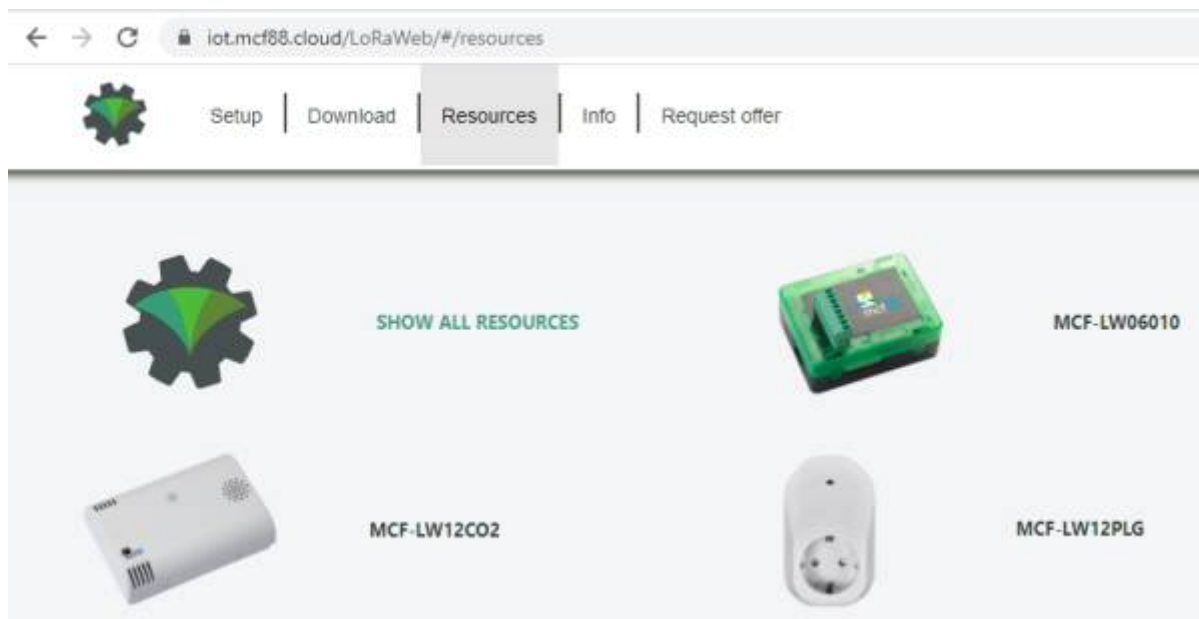

9 Payload

For payload descriptions, uplinks and downlinks format and available commands please refer to this document:

[DATA FRAME FORMAT](#)

10 Ordering code

Code	Description
MCF-LW12MET	enginko LoRaWAN® mono-phase metering EU863-870
MCF-LW12MET-AS	enginko LoRaWAN® mono-phase metering AS920-925
MCF-LW12MET-US	enginko LoRaWAN® mono-phase metering US902-928
MCF-LW12MET-AU	enginko LoRaWAN® mono-phase metering AU915-928
MCF-LW12MET-WW	enginko LoRa® mono-phase metering 2.4GHz

11 Declaration of conformity

Hereby, enginko Srl declares that MCF-LW12MET complies with the essential requirements and other relevant provisions of Directive 2014/53/EU.

12 Contacts

enginko Srl

Via Roma 3 I-28060 Sozzago (NO)

T : +39 0321 15 93 088

E : info@enginko.com

PEC: enginkosrl@legalmail.it

W: enginko.com

rev. 0

From:

<https://enginko.com/support/> - **enginko.support.center**

Permanent link:

https://enginko.com/support/doku.php?id=manual_mcf-lw12met&rev=1678780657

Last update: **2023/05/29 07:33**

