

# Table of Contents

- MCF-LW06485 Operating Manual** ..... 1
- 1. Description** ..... 1
- 2. Overview** ..... 2
  - 2.1 Technical data ..... 3
- 3 Installation** ..... 3
  - 3.1 Connection ..... 3
  - 3.2 Configuration ..... 5
  - 3.3 System led ..... 6
  - 3.4 Firmware update ..... 7
- 4. Setup** ..... 7
  - 4.1 Period ..... 8
  - 4.2 Modbus settings ..... 8
    - 4.2.1 Serial line settings ..... 8
    - 4.2.2 Registers map configuration ..... 9
  - 4.3 Other settings ..... 12
- 5. Diagnostic** ..... 12
- 6 LoRaWAN network** ..... 13
  - 6.1 Activation ..... 14
  - 6.2 Other settings ..... 15
- 7 Passwords** ..... 15
- 8 General configuration file** ..... 16
  - 8.1 Multi devices configuration ..... 17
- 9 Payload** ..... 18
- 10 Ordering code** ..... 18
- 11 Modbus overview** ..... 19
- 12 Declaration of conformity** ..... 22
- 13 FCC compliance for MCF-LW06485-US** ..... 22
- 14 Contacts** ..... 23





# MCF-LW06485 Operating Manual

## Important safety information



Read this manual before attempting to install the device! Failure to observe recommendations included in this manual may be dangerous or cause a violation of the law. The manufacturer will not be held responsible for any loss or damage resulting from not following the instructions of this operating manual.

- Do not dismantle or modify in any way.
- Avoid mechanical stress
- Do not use any detergent or alcohol to clean the device.

## Disposal information for users



**Pursuant to and in accordance with Article 14 of the Directive 2012/19/EU of the European Parliament on waste electrical and electronic equipment (WEEE), and pursuant to and in accordance with Article 20 of the Directive 2013/56/EU of the European Parliament on batteries and accumulators and waste batteries.**

The barred symbol of the rubbish bin shown on the equipment indicates that, at the end of its useful life, the product must be collected separately from other waste.

Please note that the lithium batteries must be removed from the equipment before it is given as waste and disposed separately. To remove the batteries refer to the specifications in the user manual. For additional information and how to carry out disposal, please contact the certified disposal service providers.

## 1. Description

This device can be interfaced to any Modbus RTU RS485 device to read and write any register of the connected device (up to 31 slaves or 512 bytes of data for every message) through the LoRaWAN® platform. Configuration is simply made using a configuration file uploaded to the interface via USB or with downlinks.



MCF-LW06485 is available with DIN rail option (MCF-DIN105):



## 2. Overview

## 2.1 Technical data

- CPU Cortex M4
- RTC
- EEPROM 32KB
- Flash 1MB
- Encryption AES 128 bit
- LiPo 800mAh rechargeable battery
- Class C LoRaWAN® stack EU868, AS923, AU915, US915
- Modbus RTU RS485
- Integrated termination and polarization resistors
- USB On The Go
- IoT node setup and firmware upgrade via USB interface
- Power supply 10÷36Vdc
- Storage temperature range -20°C ÷ +80°C
- Working temperature range -10°C ÷ +70°C
- Dimensions L x H x P: 81 x 60 x 24mm

## 3 Installation

### 3.1 Connection

#### 3.1.1 Connection as stand-alone device

Please refer to following connections:



pin	Name	Description
J3.7	IO5	Modbus A (+) yellow wire
J3.8	IO6	Modbus B (-) white wire

J3.9	GND	Negative power supply
J3.10	VDD	Positive power supply range [10-36Vdc]

Power can also be supplied by USB.

### 3.1.2 Connection with DIN rail option

Please refer to following connections:



Modbus data lines:

Pin	Name	Description
J1.7	IO5	Modbus A (+)
J1.8	IO6	Modbus B (-)

Power supply:

Pin	Name	Description
J2.1	Vdc	Positive power supply range [10-36Vdc]
J2.2	GND	Negative power supply

Floor consumption (included termination and polarization resistors): 425mW

Note: add 600mW for a duration of 2 seconds for every LoRaWAN transmission (in the worst case), and/or 150mW for the duration of the ModBus communication.

Power can also be supplied by USB.

### 3.1.3 Termination/Polarization



- dip1 ON/OFF = 120 OHM termination on Modbus INSERTED/NOT INSERTED
- dip2 ON/OFF = Modbus B line polarization INSERTED/NOT INSERTED\*
- dip3 ON/OFF = Modbus A line polarization INSERTED/NOT INSERTED\*

\*Polarizations are available only if MCF-LW06485 is 10-36Vdc supplied. Please note dip2 and dip3 must have same status.

### 3.1.4 Antenna

The magnetic antenna must be positioned on a metal body. It should preferably be vertical and at least 30 cm away from other metal bodies. The installation must take place in a place where the LoRaWAN® signal coverage is good (SF=7 optimal, SF=12 weak). Use the provided clip to hold the antenna connector in place, as in the picture:



## 3.2 Configuration

To deploy the sensor, use **LoRaWEB** online tool, to setup LoRaWAN® credentials and other preferences (only available for Windows®) :

[LoRaWEB Tool](http://iot.mcf88.cloud/LoRaWeb) (iot.mcf88.cloud/LoRaWeb)

Before connect the device the first time, please install LoRaBridge applicarions and drivers:

<https://iot.mcf88.cloud/LoRaWeb/#/download>





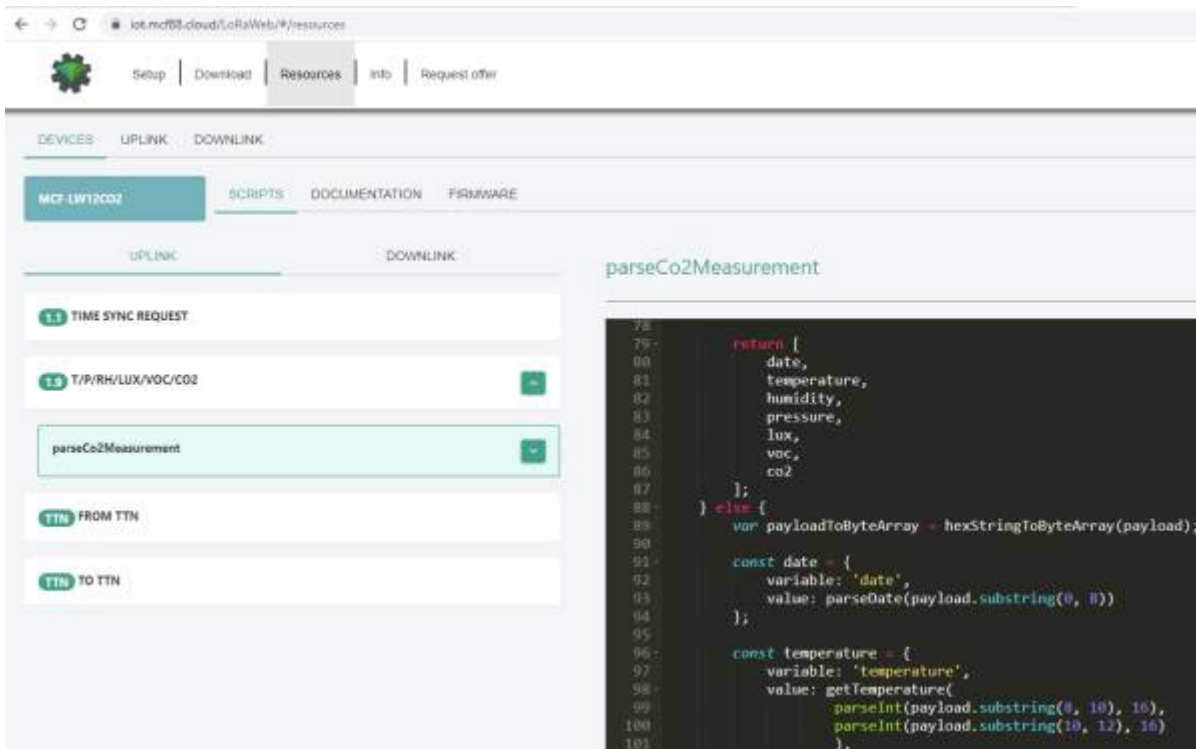
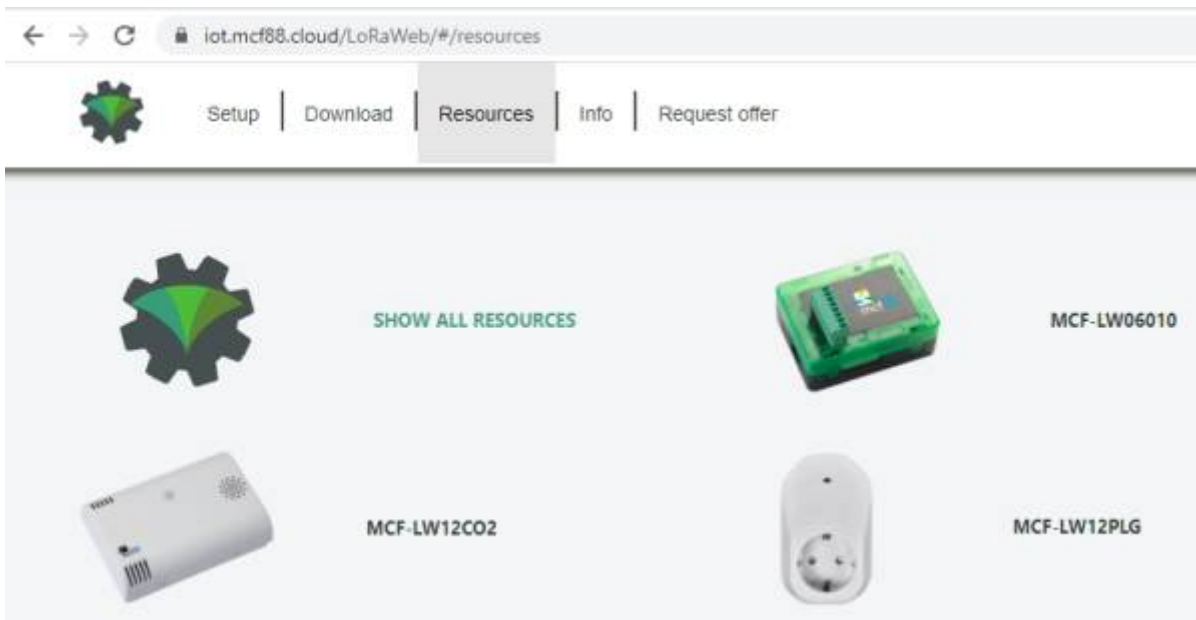

Validate your settings reading data after the write.

enginko provides, upon free registration, user manuals, javascript examples, downlink generator, uplink decoder, firmware updates and different tools :



### 3.3 System led

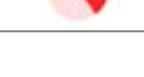

LoRaWAN® not configured		Slow flashing
Joining		Quick flashing
Sending		Quick flashing
Receiving		Quick flashing
Steady state		Fixed
Data error		Flashing 2 seconds
Connection error		Flashing 1 second

### 3.4 Firmware update

Save the new firmware file (.exe) on the PC, run the file, select the USB FW port and start the update:

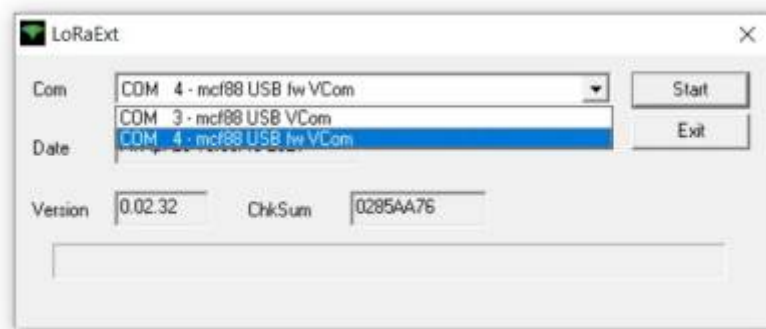

and waiting for the end message.

## 4. Setup

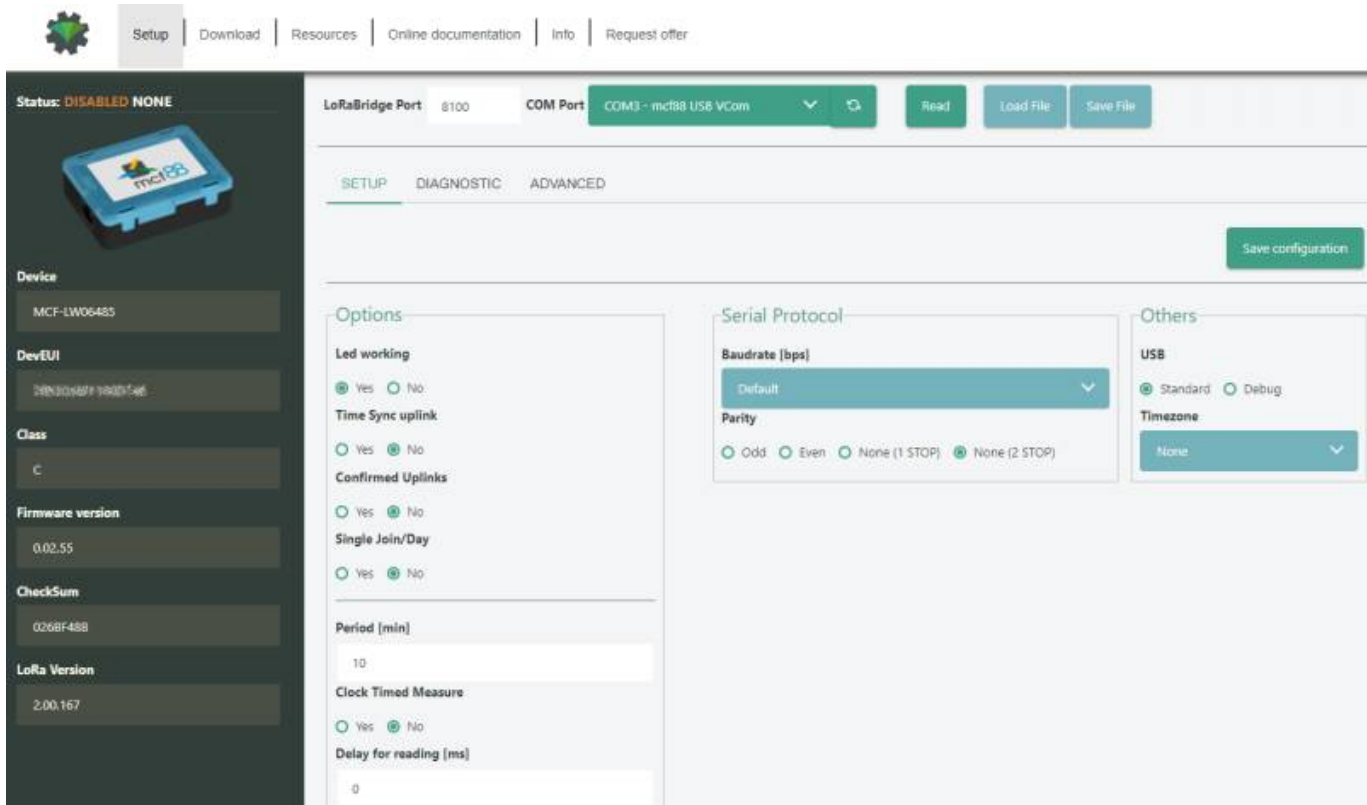

## 4.1 Period

Period is the interval (in minutes) between one measure and the next one. The sensor sends one measures for every transmission. Value can be between 5 and 65535 minutes (default: 10 minutes).

Period interval can be set with LoRaWEB or with downlink command.

## 4.2 Modbus settings

### 4.2.1 Serial line settings

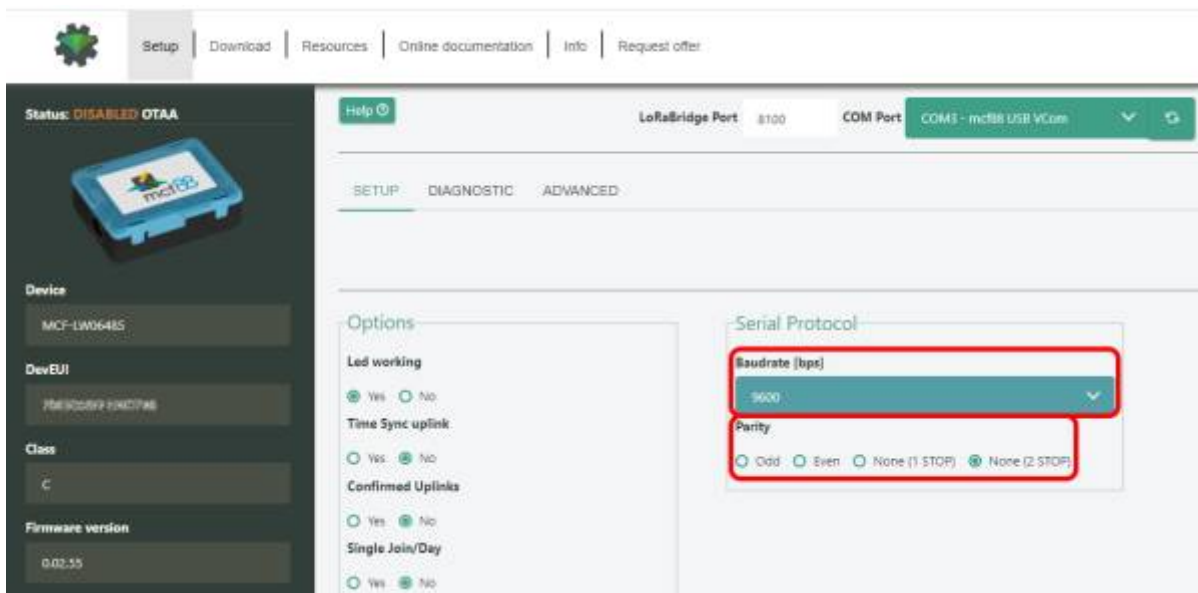

**Baudrate [bps]:**

set the baudrate for the serial line (default = off).

**Parity:**

set the Modbus frame parity.

**Note:**

when saving these parameters, the system asks if you want to save only or to save and load the Modbus configuration file.

## 4.2.2 Registers map configuration

Basic configuration is made through an .XLS file containing, for every row, the parameters of the register(s) to be read or write.

	A	B	C	D	E	F	G	H
1	Label	Modbus address	Modbus function	Dec address	Modbus length	Data	Baudrate (bps)	Parity/stop
2								
3								
4								

Template file can be downloaded here:

[Modbus configuration file template](#)

File can be uploaded via USB or sent with LoRaWAN® dowlinks.

Due to the radio regulation, the amount of data that the interface can send during a period of time can vary, and depends also from duty cycle, spreading factor and data rate.

For example, with EU868 band, the MCF-LW06485 can send from 1KB (SF = 12) to 30KB (SF = 7) every hour. In case of periodic transmission, you have to set the reading period related to the amount of data you have to send for every reading from the slaves.

## 4.2.3 Configuration file format

**Label:**

mnemonic label of the register.

**Modbus address:**

slave address (expressed as decimal value)

**Modbus function:**

Function Code	Register Type
1	Read Coil
2	Read Discrete Input
3	Read Holding Registers
4	Read Input Registers
5	Write Single Coil
6	Write Single Holding Register

15	Write Multiple Coils
16	Write Multiple Holding Registers

**Dec address:**

register starting address (expressed as decimal value), without offset.

Note:

please check [Modbus addressing](#)

**Modbus length:**

length (in word) of the register to be read or write.

Attention: in case of "Write Single Coil", length must be 1, and data 00 (disable) or 01 (enable).

In case of "Write Multiple Coils", Length is the number of coils, and data must be n byte long, with  $n = (\text{length} + 7) / 8$ .

**Data:**

in case of write command, data to be write, hexadecimal values formatted as string.

Always use ' (single quote) before the digits).

**Baudrate (bps):**

serial line baudrate, only needed if different from the settings in LoRaWEB.

Allowed values: 1200, 2400, 4800, 9600, 19200. 38400, 57600, 115200.

**Parity/stop:**

serial line parity/stop, only needed if different from the settings in LoRaWEB.

Allowed values: 8-n-1, 8-n-2, 8-e-1, 8- o -1 for none, even or odd

**Examples:**

reading a 2 byte holding register, starting from address 10001 of slave 1

Label	Modbus address	Modbus function	Dec address	Modbus length	Data	Baudrate (bps)	Parity/stop
Input status	1	3	10001	1			

writing a 2 byte holding register (with value 1000h), starting from address 53 of slave 2:

Label	Modbus address	Modbus function	Dec address	Modbus length	Data	Baudrate (bps)	Parity/stop
Analog output 1	2	6	53	1	1000		

**4.2.4 Configuration with downlinks**



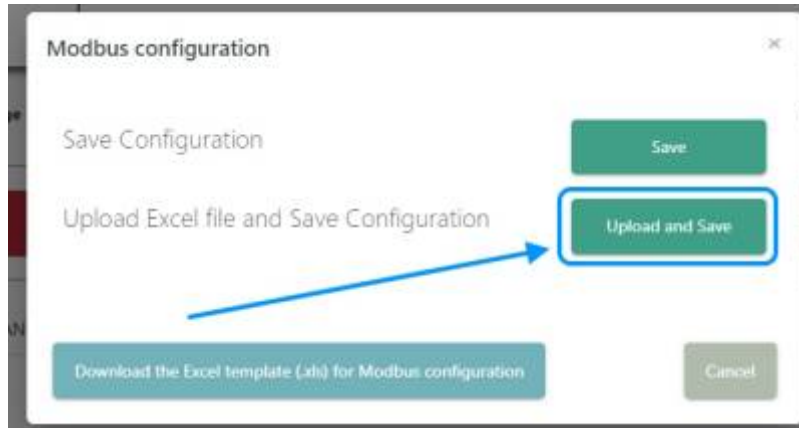

### 4.2.5 Configuration with downlinks

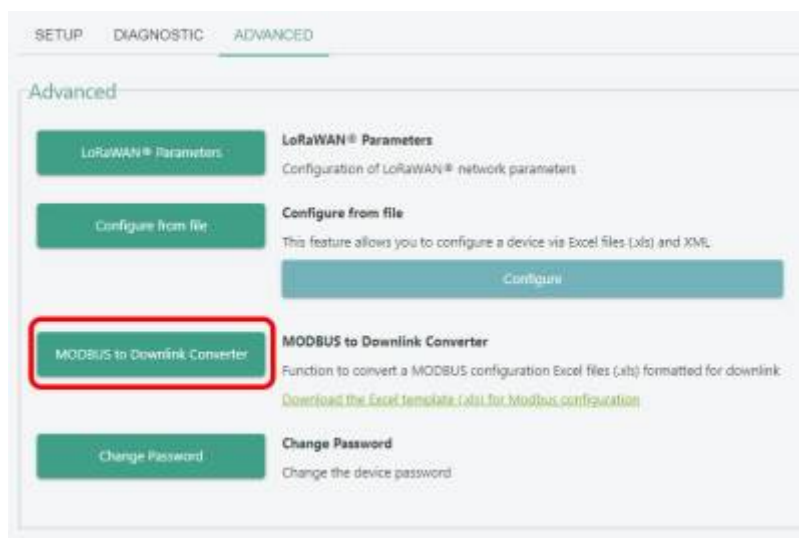

#### **MODBUS to Downlink converter:**

convert the .XLS configuration file in one or more downlink payload to be sent to the device instead using USB port-



#### **Temporary Downlink:**

the configuration file is executed and then discarded.

#### **Configuration Downlink:**

the configuration file is saved in memory and executed periodically.

## 4.3 Other settings

### **Delay for reading [ms]:**

delay added between the reading of one Modbus register and the one (default = 0).

### **DST:**

set to change DST (default: none).

### **Time sync uplink:**

set to disable time synchronization request (default: enabled).



Normally sensor asks for a time sync at every power on (uplink starting with 01) or once a week. If no or wrong reply received, it will retry after 1 week.

If not handled in the right way can generate unnecessary traffic on the network.

Please check chapter 2.1 [DATA FRAME FORMAT](#).

---

### **Confirmed Uplinks:**

set for unconfirmed uplinks (default: confirmed uplink).

### **Single join/day:**

set for to allow only one join per day (default: multiple join allowed).

### **LED working:**

Set OFF to turn off the diagnostic led.

### **USB:**

Internal use.

## 5. Diagnostic

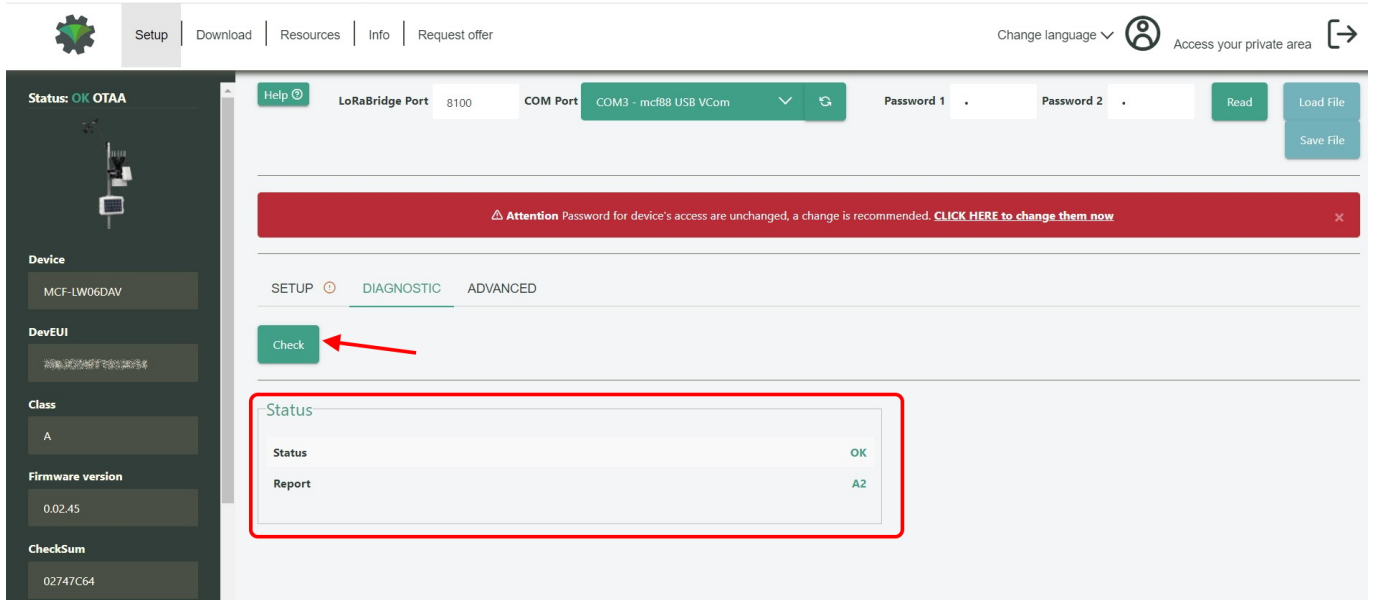

Press **Check** to verify the correct communication between the LoRaWAN® interface and the slave(s).

## 6 LoRaWAN network

The sensor is compliant with LoRaWAN® **specification 1.0.2, regional 1.0.2b.**

## LoRaWAN® Parameters



**LoRaWAN®**

<b>Network Key</b>	<b>App Key</b>
<input type="text"/>	<input type="text"/>
<b>Device Address</b>	
<input type="text"/>	
<b>AppEUI</b>	<b>DevEUI</b>
<input type="text"/>	<input type="text"/>
<b>LoRa Band</b>	
EU 868 MHz - Europe	
<b>LoRaWAN® Activation</b>	
<input type="radio"/> NONE <input type="radio"/> OTAA MCF88 <input type="radio"/> OTAA ENGINKO <input checked="" type="radio"/> OTAA <input type="radio"/> ABP	
<b>Network settings</b>	
<input checked="" type="radio"/> Any <input type="radio"/> Objenious	
<b>Network type</b>	
<input checked="" type="radio"/> Public Network <input type="radio"/> Private Network	

### 6.1 Activation

The device supports the following activations on a LoRaWAN® network:

1. **NONE**: sensor not activated
2. **OTAA**: the JoinEUI and the AppKey not setted, must be written to the device;
3. **OTAA MCF88**: Over the air activation, fixed keys: JoinEUI = 904e915000000002, AppKey on request;
4. **OTAA ENGINKO**: Over the air activation, fixed keys: JoinEUI = 904e915000000002, AppKey on request;
5. **ABP**: requires writing to the device of NwkSkey, AppSkey, DevAddr.

LoRaWAN® Parameters x

**LoRaWAN®**

**Network Key** **App Key**

**Device Address**

**AppEUI** **DevEUI**

**LoRa Band**

EU 868 MHz - Europe v

**LoRaWAN® Activation**

NONE  OTAA MCF88  OTAA ENGINKO  OTAA  ABP

**Network settings**

Any  Objenious

**Network type**

Public Network  Private Network

Read Save File Cancel Save LoRaWAN® parameters

The device exits factory activated with **NONE** mode. On request devices can be shipped already activated.

Note: in **OTAA** AppKey is write only, in reading the field will always be empty, even if set.

## 6.2 Other settings

### Network settings:

please keep "Any" settings. Change it only if Objenious network is used (default\_ any).

### Network type:

LoRa syncword can be setted as "private"(0x12) instead "public" (0x34), but the NS must be setted accordingly (default: public).

### Band:

select the right LoRaWAN® band settings accordingly to country requirements.

## 7 Passwords

The device can be protected by passwords, to avoid unauthorized persons to read data or modify parameters.

As default passwords are equal to 0.

Allowed values range from 0 to 999999999 (only numbers).

To change the passwords, set the new values with LoRaWEB:

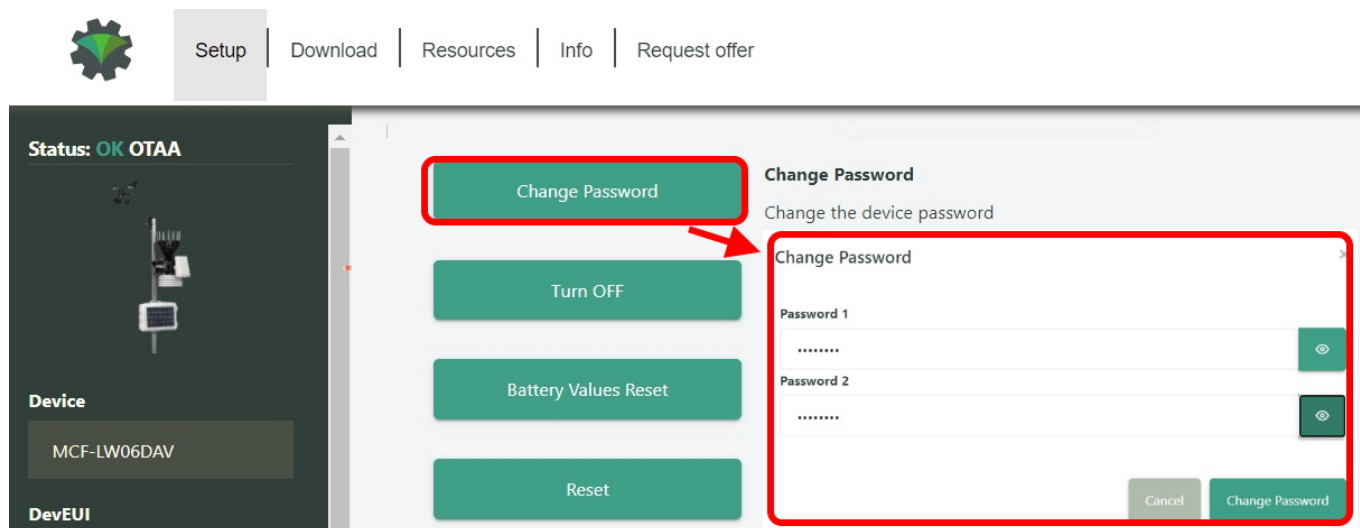

Once the passwords are setted, to gain access from LoRaWEB to the sensor, set the right values before reading from the device:

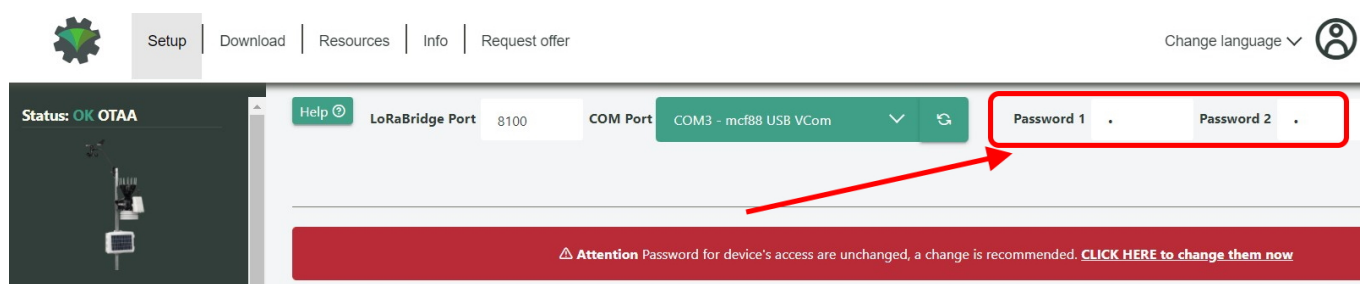

To bring back the sensor to factory default and reset the passwords, a reset code must be requested to enginko (please provide the DevEUI of the sensor when you ask for that code).

## 8 General configuration file

With LoRaWEB is possible to configure the device using an XML file, instead to manually adjust the parameters (for details about the file format please ask to enginko). This is very useful especially in case of multiple devices configuration.

With "Save" button an XML file with the actual configuration of the sensor will be generated. This is useful to store or clone the configuration, or to send it to enginko's support if needed.



## 8.1 Multi devices configuration

With LoRaWEB is possible to configure many devices in an easy way.

For multi-configuration is needed at least one XML file with the parameters to set.

Settings on this file will be applied to all the sensors.

With an additional XLS file is possible to load different LoRa configuration parameters (Activation Type, AppKey, AppEUI, NetKey, DevAddress, Band, Private option) for each sensor, based on DevEUI.

XLS is prevailing on the XML, so if both files are enabled, if the DevEUI of the device matches one of the DevEUIs in the XLS file, LoRa parameters will be setted from this one.

These configuration can be done in the in the Settings:

- Use of the general configuration by file;
- Use of the specific configuration by file.

**Configure from file**

This feature allows you to configure a device via Excel files (.xls) and XML

**Configure**

**Check Excel files**

Yes  No

**Upload Excel files (.xls) for LoRaWAN® parameters configuration**

Choose File ... **Load File**

[Download Excel template \(.xls\) for a LoRaWAN® specific configuration by DevEUI](#)

---

**Check XML file**

Yes  No

**Upload XML file for the generic configuration of the device**

Choose File ... **Load File**

For details on files format please ask to enginko.

## 9 Payload

For payload descriptions, uplinks and downlinks format and available commands please refer to this document:

[DATA FRAME FORMAT](#)

## 10 Ordering code

Code	Description
MCF-LW06485	ModBus RTU RS485 to LoRaWAN® interface EU863-870
MCF-LW06485-AS	ModBus RTU RS485 to LoRaWAN® interface AS920-925
MCF-LW06485-US	ModBus RTU RS485 to LoRaWAN® interface US902-928
MCF-LW06485-AU	ModBus RTU RS485 to LoRaWAN® interface AU915-928

For payload descriptions, uplinks and downlinks format and available commands please refer to this document:

## DATA FRAME FORMAT

# 11 Modbus overview

## 11.1 Modbus RTU basics

Modbus RTU is based on an RS485 bus: TIA/EIA-485 (RS-485) is a single differential balanced line (half duplex).

- It provides a robust communication interface which is inherently noise tolerant since it uses differential as opposed to ground referenced signals.
- It can be cheaply deployed & the cabling is simple, a single pair of wires plus a ground wire.
- Up to 32 devices can be daisy-chained together in a network.

## 11.2 Modbus RTU basics: termination resistors

In order to avoid signal reflections, a 120 Ohm termination resistance must be fitted on each end of the main cable:

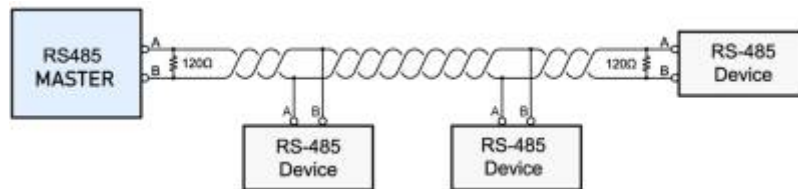

If the data rate is low or cables are short, termination may be unnecessary. As data rates and/or cable lengths increase, which is most cases, termination becomes mandatory. If the total length of the main cable is less than 50m termination resistances can be avoided at the ends of the main cable.

Note: Since is a differential line, the cable to be used is a shielded twisted pair.



The cable shield must be earthed only in one point. Normally, this connection is made at one end of the main cable.

## 11.3 Modbus RTU basics: bias resistors

With RS485 networks, there are periods of time when no driver is actively driving the bus (tri-state) And the termination resistors collapse the differential bus voltage to 0V, which is an undefined input level for many RS485 receivers.

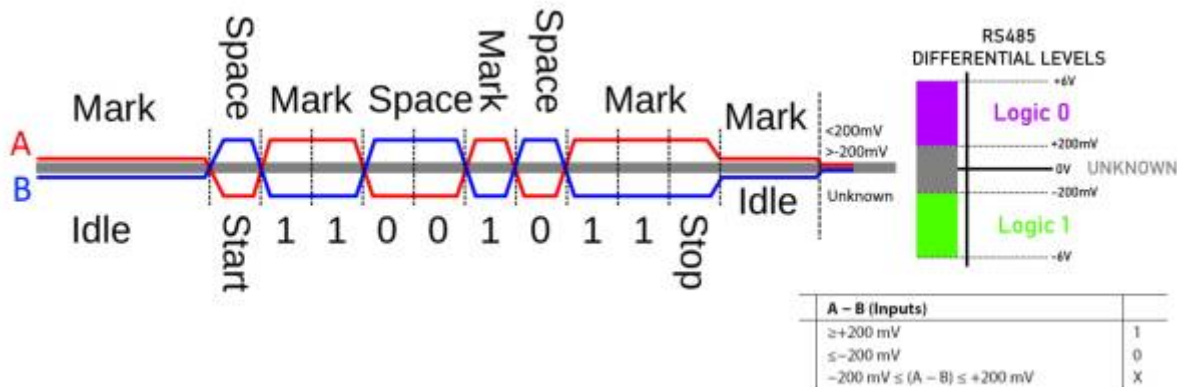

The objective of biasing is to make sure that the RS485 line remains in a known, non-fluctuating state when no devices are transmitting. Polarization of the pair must be implemented at one location for the whole serial bus. Biasing the entire network requires a single pair of polarization resistors: a pull-up resistor to +5V attached to the “+” signal line, and a pull-down resistor to ground attached to the “-” signal line.

### 11.4 Modbus RTU basics: data format

The format for each byte ( 11 bits ) in RTU mode is :

- 1 start bit
- 8 data bits ( least significant bit sent first)
- 1 bit for parity completion
- 1 stop bit

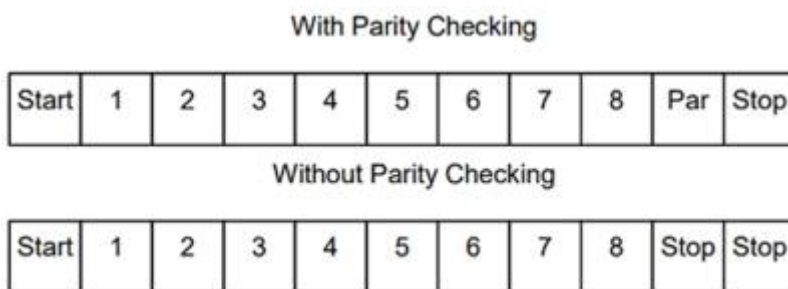

Even parity is required, other modes ( odd parity, no parity ) may also be used. In order to ensure a maximum compatibility with other products, it is recommended to support also No parity mode. The default parity mode must be even parity. Remark: the use of no parity requires 2 stop bits.

### 11.5 Modbus RTU basics: registers addressing

Modbus registers by definition are associated with a function, and an offset within that function. The

two common (16-bit) data register types are commonly known as “Holding Registers” and “Input Registers” (function 03 and function 04 respectively). The specific register within the function is referenced by an offset (starting at 0). This is the actual data which is transmitted during the data query.

At some point, certain PLC manufacturers starting using a “3xxxx” or “4xxxx” reference designation in an attempt to provide an absolute address to the register (ie: which would reference both the function and the register). Some device manufacturers start their “4xxxx” references at 40001, and some start at 40000. The starting register corresponds to offset “0” within the given function.

<b>Modbus “Standard”</b>	<b>4xxxx (base 1)</b>	<b>4xxxx (base 0)</b>
Function 3, Offset 0	40001	40000
Function 3, Offset 1	40002	40001

### 11.6 Modbus RTU addressing

The types of registers referenced in Modbus devices include the following:

- Coil (Discrete Output)
- Discrete Input (or Status Input)
- Input Register
- Holding Register

Function Code	Register Type
1	Read Coil
2	Read Discrete Input
3	Read Holding Registers
4	Read Input Registers
5	Write Single Coil
6	Write Single Holding Register
15	Write Multiple Coils
16	Write Multiple Holding Registers

Whether a particular device includes all of these register types is up to the manufacturer. It is very common to find all I/O mapped to holding registers only.

- Coils are 1-bit registers, are used to control discrete outputs, and may be read or written.
- Discrete Inputs are 1-bit registers used as inputs, and may only be read.
- Input registers are 16-bit registers used for input, and may only be read.
- Holding registers are the most universal 16-bit register, may be read or written, and may be used for a variety of things including inputs, outputs, configuration data, or any requirement for “holding” data.

### 11.7 Modbus summarized

- Use a twisted pair cable (shielded, if possible)
- Check the polarity of the wires (different names for different manufacturers: A, B, D+, D-...)

- Always place at least 1 termination resistor (at the end(s) of the bus)
- Don't leave the termination resistor(s) without polarization. Place the bias resistors only in 1 point of the bus:

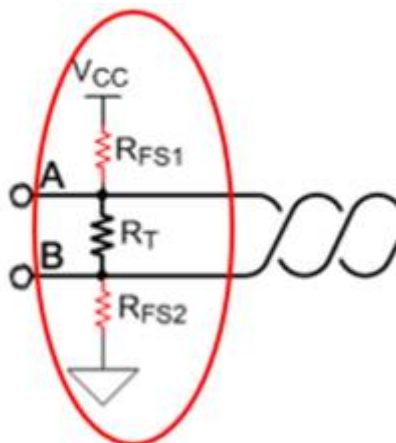

- Avoid stubs:

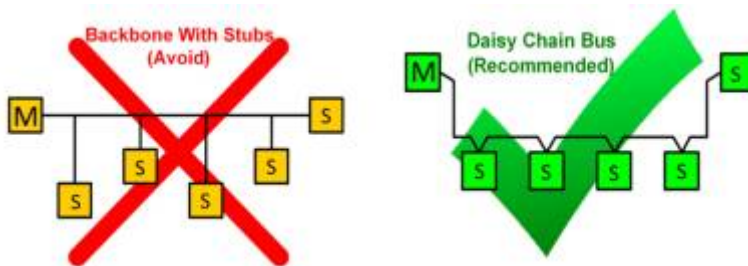

- Double check the addressing of the registers (standard, absolute, offset base 1, offset base 0...)

## 12 Declaration of conformity

Hereby, enginko Srl declares that MCF-LW06485 complies with the essential requirements and other relevant provisions of Directive 2014/53/EU.

## 13 FCC compliance for MCF-LW06485-US

This device complies with part 15 of the FCC Rules. Operation is subject to the following two conditions: (1) This device may not cause harmful interference, and (2) this device must accept any interference received, including interference that may cause undesired operation.

This equipment has been tested and found to comply with the limits for a Class B digital device, pursuant to part 15 of the FCC Rules. These limits are designed to provide reasonable protection against harmful interference in a residential installation. This equipment generates, uses and can radiate radio frequency energy and, if not installed and used in accordance with the instructions, may cause harmful interference to radio communications. However, there is no guarantee that interference will not occur in a particular installation. If this equipment does cause harmful interference to radio or television reception, which can be determined by turning the equipment off

and on, the user is encouraged to try to correct the interference by one or more of the following measures:

- Reorient or relocate the receiving antenna.
- Increase the separation between the equipment and receiver.
- Connect the equipment into an outlet on a circuit different from that to which the receiver is connected.
- Consult the dealer or an experienced radio/TV technician for help.

Any changes or modifications not expressly approved by the party responsible for compliance could void the user's authority to operate this equipment.

**Contains FCC ID: 2AWAL409810**

## 14 Contacts

### **enginko Srl**

Via Roma 3 I-28060 Sozzago (NO)

T : +39 0321 15 93 088

E : [info@enginko.com](mailto:info@enginko.com)

PEC: [enginkosrl@legalmail.it](mailto:enginkosrl@legalmail.it)

W: [enginko.com](http://enginko.com)

---

rev.1

From:

<https://enginko.com/support/> - **enginko.support.center**

Permanent link:

[https://enginko.com/support/doku.php?id=manual\\_mcf-lw06485&rev=1718203639](https://enginko.com/support/doku.php?id=manual_mcf-lw06485&rev=1718203639)

Last update: **2024/06/12 16:47**

