

Table of Contents

- EGK-LW22CCM Operating Manual** 1
- 1. Description** 1
- 2. Overview** 2
 - 2.1 Technical data 2
 - 2.2 Installation 2
 - 2.3 Power ON/OFF 10
 - 2.4 System leds 12
 - 2.5 Push button 12
 - 2.6 Battery 13
 - 2.7 Firmware update 16
- 3. Measures** 19
 - 3.1 Period 20
 - 3.2 Temperature 22
 - 3.3 Humidity 23
 - 3.5 Log data 23
- 4 LoRaWAN network** 25
 - 4.1 Activation 26
 - 4.2 Other settings 27
- 5 Passwords** 28
- 6 Configuration file** 30
 - 6.1 Multi devices configuration 31
- 7 LoRaWEB Tool** 32
- 8 Payload** 33
- 9 Ordering code** 33
- 10 Maintenance** 33
- 11 Declaration of conformity** 33
- 12 Contacts** 34



EGK-LW22CCM Operating Manual

Important safety information



Read this manual before attempting to install the device! Failure to observe recommendations included in this manual may be dangerous or cause a violation of the law. The manufacturer will not be held responsible for any loss or damage resulting from not following the instructions of this operating manual.

- Do not dismantle or modify in any way.
- The device is not intended to be used as a reference sensor, and enginko Srl will not be held liable for any damage which may result from inaccurate readings.
- Avoid mechanical stress
- Do not use any detergent or alcohol to clean the device.
- Risk of explosion if the battery is replaced with an incorrect type.
- Risk of explosion if the battery pack is subjected to a short circuit.
- Risk of explosion if the battery is burned or placed near high heat sources.
- Risk of explosion if batteries are crushed, punctured or cut.
- Do not expose batteries to contact with liquid substances.

Disposal information for users



Pursuant to and in accordance with Article 14 of the Directive 2012/19/EU of the European Parliament on waste electrical and electronic equipment (WEEE), and pursuant to and in accordance with Article 20 of the Directive 2013/56/EU of the European Parliament on batteries and accumulators and waste batteries.

The barred symbol of the rubbish bin shown on the equipment indicates that, at the end of its useful life, the product must be collected separately from other waste.

Please note that the lithium batteries must be removed from the equipment before it is given as waste and disposed separately. To remove the batteries refer to the specifications in the user manual. For additional information and how to carry out disposal, please contact the certified disposal service providers.

1. Description

The EGK-LW22CCM is a IP65 battery powered device for temperature and humidity measurements. This small-sized device is designed for all situations where it is necessary to keep temperature and humidity under control, from catering to medical and pharmaceutical applications, from museum environments to vaults and wine cellars. The multifunction button and the colored LEDs, combined

with the Bluetooth connection, guarantee ease of configuration and control. The device can store up to 3000 sets of historical data records with time stamps, even without connection. Historical data can be retrieved via Bluetooth by LoraTool App or via LoRaWAN network by uplinks.

2. Overview

2.1 Technical data

- CPU ARM Cortex M4
- Class A LoRaWAN® 1.0.2 , EU868
- OTAA/ABP activation
- Temperature $-40 \div 70^{\circ}\text{C}$ (typ. $\pm 0.48^{\circ}\text{C}$ within $[-30 \div 70^{\circ}\text{C}]$, typ. $\pm 0.60^{\circ}\text{C}$ otherwise)
- Humidity 0% to 100% with following error @25°C:
 - From 0% to 10% $\pm 4\%$
 - From 10% to 90% $\pm 2\%$
 - From 90% to 100% $\pm 4\%$

- Embedded antenna
- Magnetic start-up
- Food-Grade Enclosure
- Time interval based or thresholds based uplink ¹⁾
- Historical data can be retrieved on request via BLE or LoRaWAN®
- Pushbutton for forcing transmission or Re-Join, configuration (lockable)
- 2xCR123A batteries, replacement possible
- Pole or wall mount with Dual Lock™ fastener
- 9 years life time with SF12 and max Tx power, 48 Uplinks messages per day
- Transmission @ 868 MHz, 14dBm max.
- BLE 5.0 interface for configuration, data reading and FW upgrade
- Remote configuration
- Up to 3000 sets of historical data records
- Storage temperature $-40^{\circ}\text{C} \div +80^{\circ}\text{C}$
- Working temperature $-40^{\circ}\text{C} \div +70^{\circ}\text{C}$
- Dimensions: 65.5×58.5×32.5mm
- Protection grade: IP65
- Weight: 95g

2.2 Installation

To ensure correct operation and reliable and consistent measurements, install the EGK-LW22CCM sensor away from direct sunlight and rain.

The device must be placed where the LoRaWAN® signal coverage is good (SF = 7 optimal, SF = 12 weak). The sensor can be installed on the wall or pole using the included accessories.

Custom brackets available on request.

2.2.1 Wall mount

The fasteners and substrate surfaces should have equilibrated for a minimum of 1 hour at temperatures of 68°F (20°C) or greater before application. These adhesive backed fasteners should be applied to surfaces that are smooth, dry and free of oils, mold release agents or other surface contaminants. The substrate should be cleaned with an appropriate cleaning method for the customer's substrate(s) and surface contaminant(s).

NOTE: Be sure to follow the manufacturer's precautions and directions for use when using solvents, or other cleaning method.

Remove the liner and without touching the adhesive, apply the fastener to the surfaces using firm roller pressure to help ensure complete adhesive contact to the substrate. The pressure-sensitive adhesive bonds on contact and parts can be handled immediately. Adhesive bond strength increases with time, pressure and temperature. A minimum of twenty four (24) hours dwell is recommended before applying a load or disengaging. Recommended time to achieve maximum bond strength is 72 hours (3 days).







For special applications or to secure the device in a stable manner, optional wall mount bracket **EGK-RAWALL** is available:

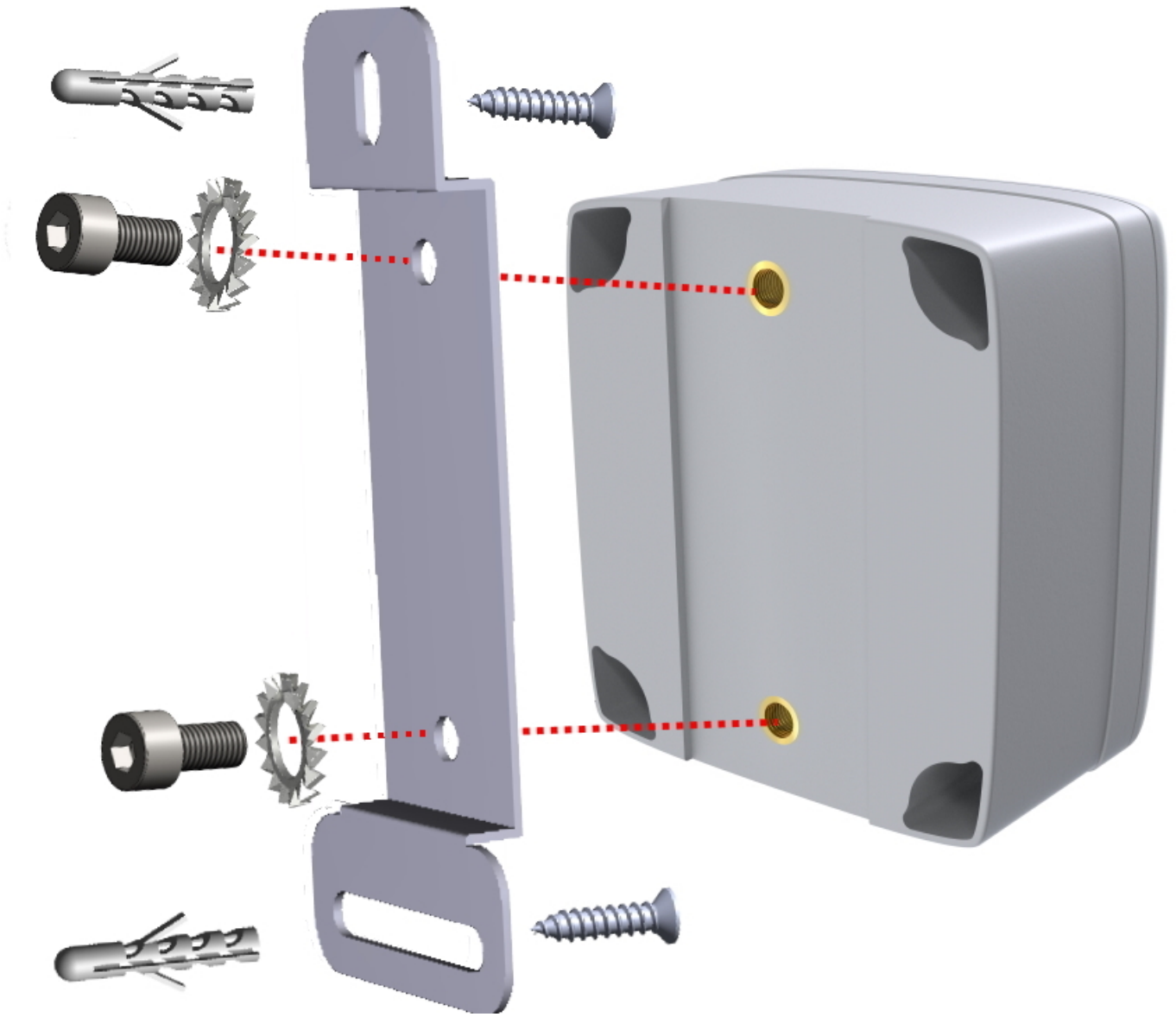

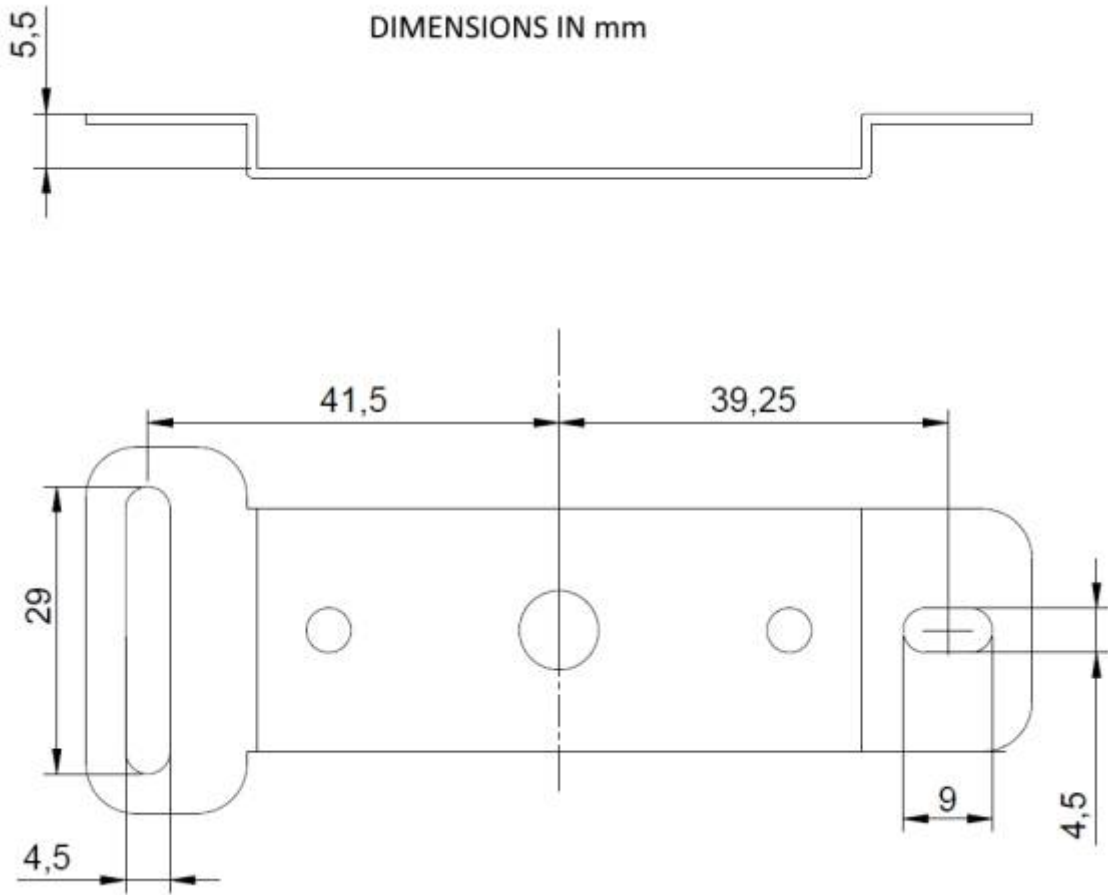

2.2.2 Pole mount

For installation on poles, pillars or posts use the included bracket and fasteners:



2.2.3 LoRa Tool

To deploy the sensor, download the latest **LoRa Tool** Android App to setup LoRaWAN® credentials and other preferences :



2.2.4 Connection

Enable the Bluetooth on the smartphone and open the App:

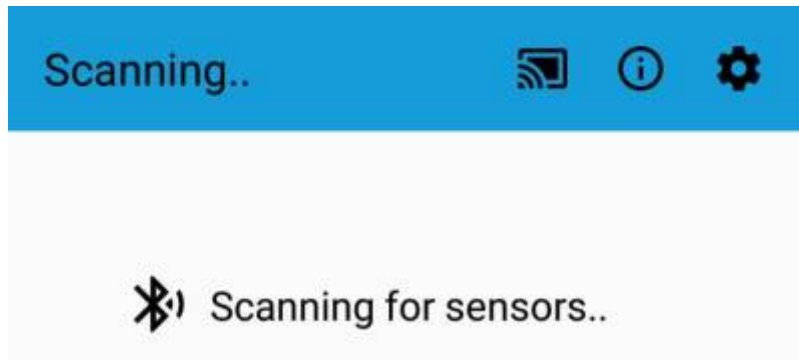

once the sensors list appears (as BLE MAC address), select the sensor you need to configure:

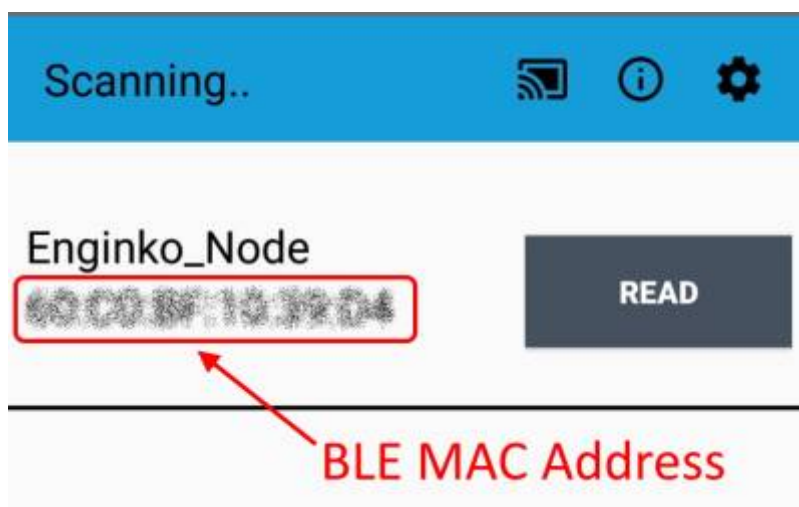

and read it:

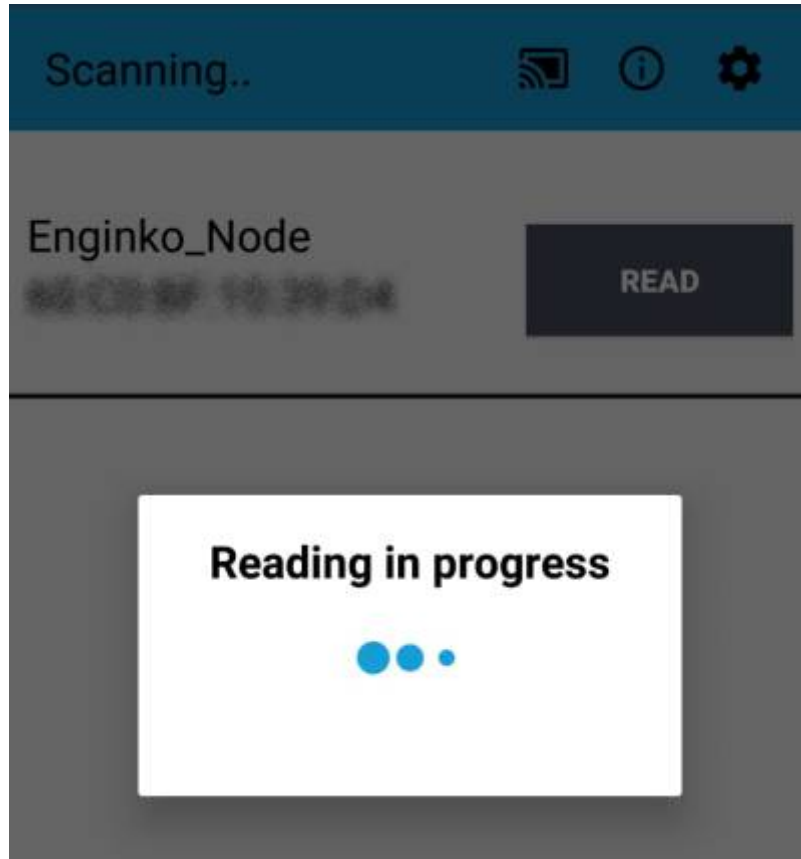

2.3 Power ON/OFF

The sensor is shipped completely off to prevent battery consumption during storage. It is therefore necessary to carry out a first power-on prior to commissioning.

To power on the sensor: lay the magnet at the bottom of the provided tool into the area shown in the figure:



Successful power on is signaled by the flashing of the 2 LEDs.

In case of long period of inactivity, if necessary, is possible to shut-off again the sensor to prevent battery consumption, via downlink or with LoRa Tool App:



or pressing the push button for more than 5 seconds.

2.4 System leds



LoRaWAN® not configured		Slow flashing
Joining		Quick flashing
Sending		Quick flashing

2.5 Push button



The function of the button changes depending on how long it is pressed:

≈ 0.5s	force an uplink with new measure
> 2s	reboot the device
> 5s	turn off the device

2.6 Battery

This sensor contains lithium battery, which must be disposed of separately.

EGK-LW22CCM is provided with two CR123A batteries.

This is the estimated battery life (in **years**) in the worst conditions:

	10min reading	15min reading	30min reading
SF12	3.5	5.0	9
SF7	> 10	> 10	> 10

2.6.1 Battery replacement

- remove the front panel of the sensor with a small hex key (for M2.5 bolts):



- remove the PCB batteries from the board and put the new ones:



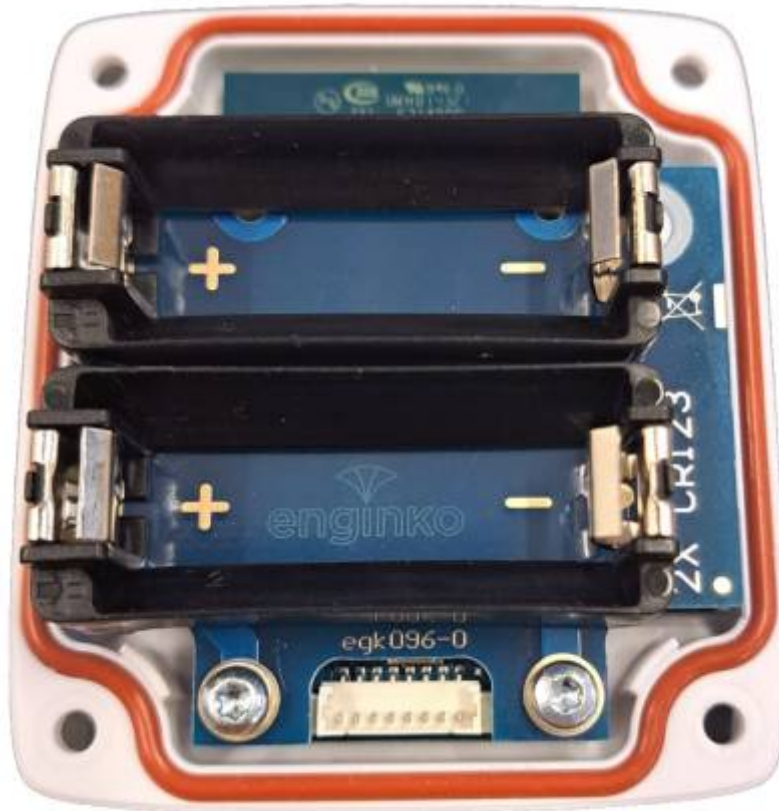

- Place the front panel and fix it with the 4 bolts.

After the batteries replacement, internal counters need to be resetted.

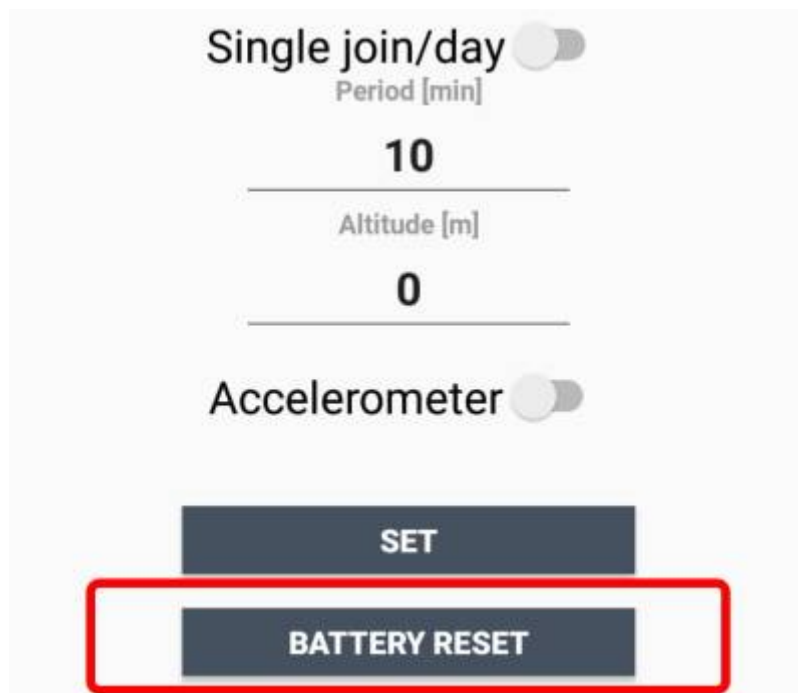

To perform the operation, you need a unique reset code that must be requested to enginko (please provide the DevEUI of the sensor when you ask for that code):

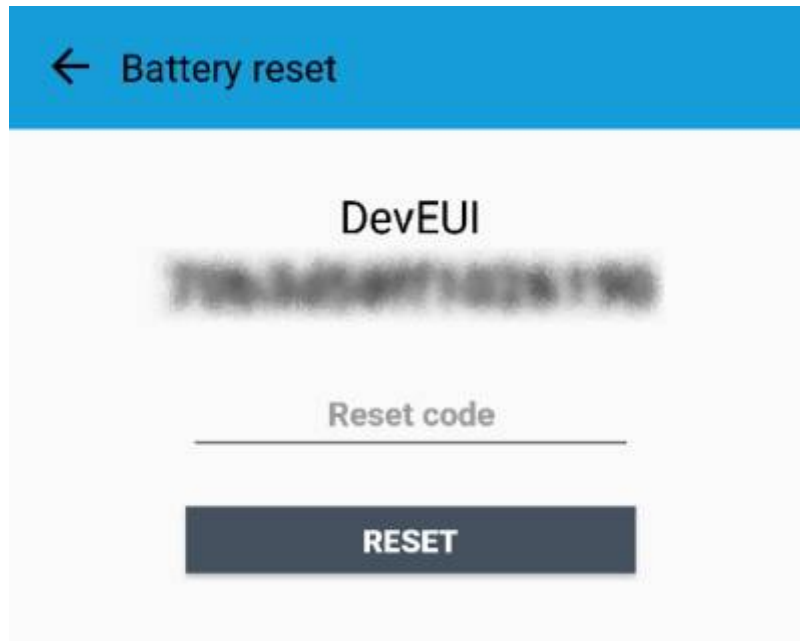

At the end of the procedure the battery level displays 100%.

2.7 Firmware update

Download the latest firmwares available on the smartphone with LoRaTool app:



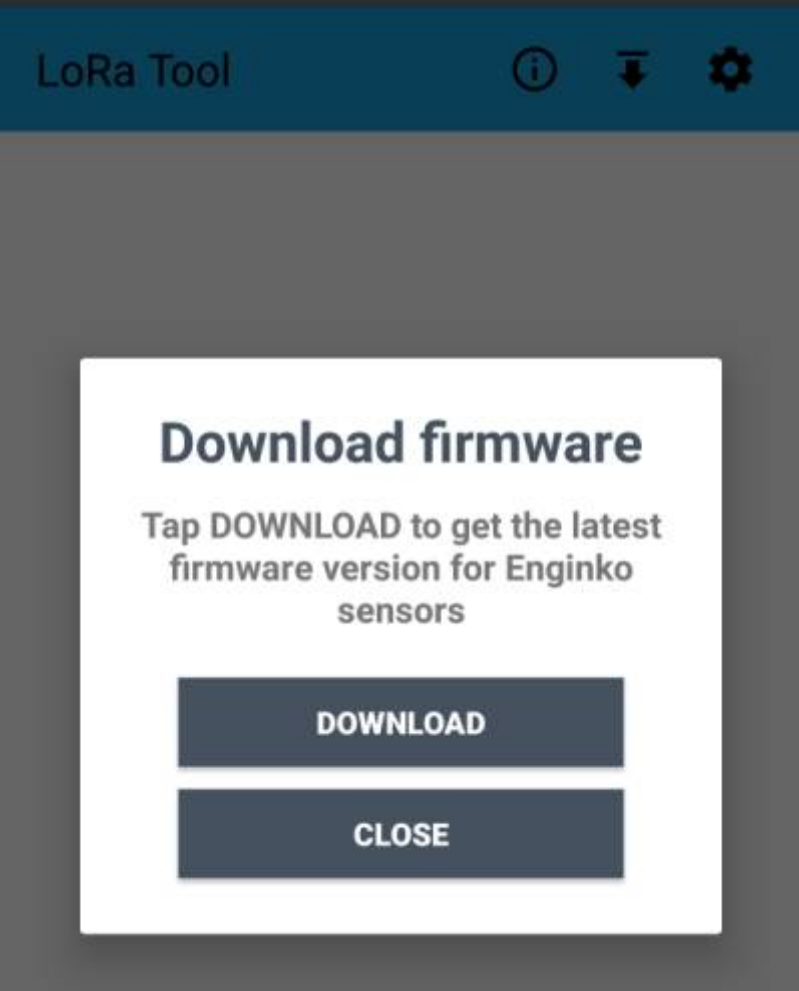

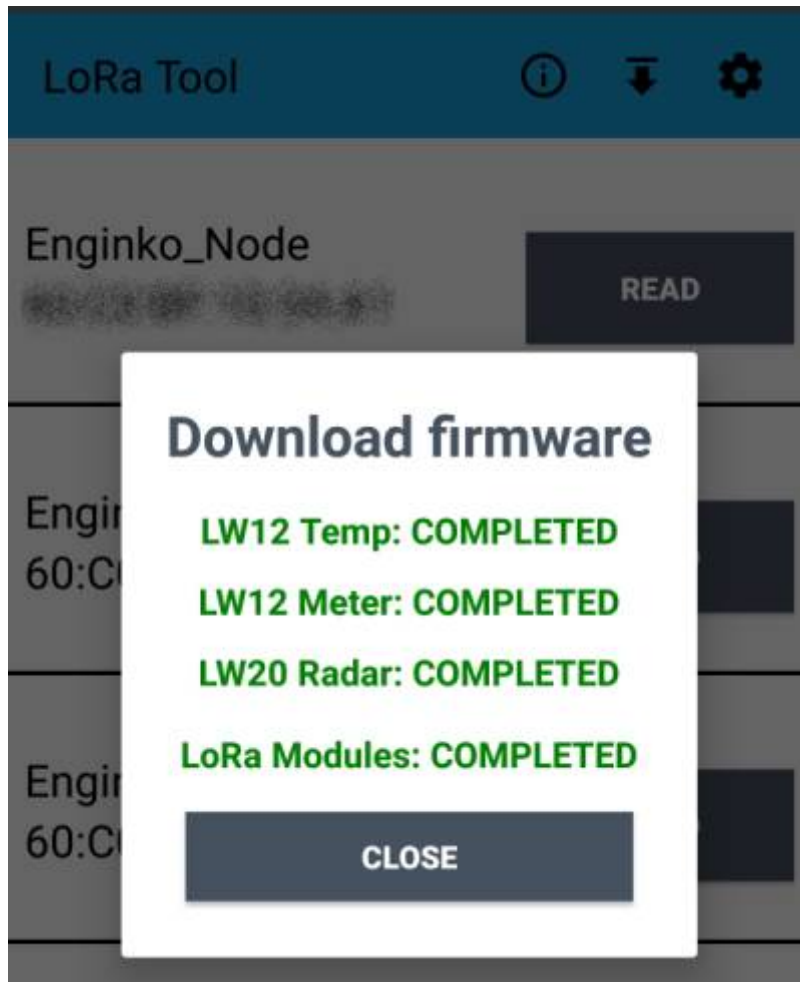

Update the sensor with LoRaTool:



During the update, do not move the smartphone until the end message.

3. Measures



3.1 Period

Period is the interval (in minutes) between one measure and the next one. When in **no Log mode** , the sensor sends one to three measures (settable) for every transmission. Value can be between 10 and 65535 minutes (default: 10 minutes)

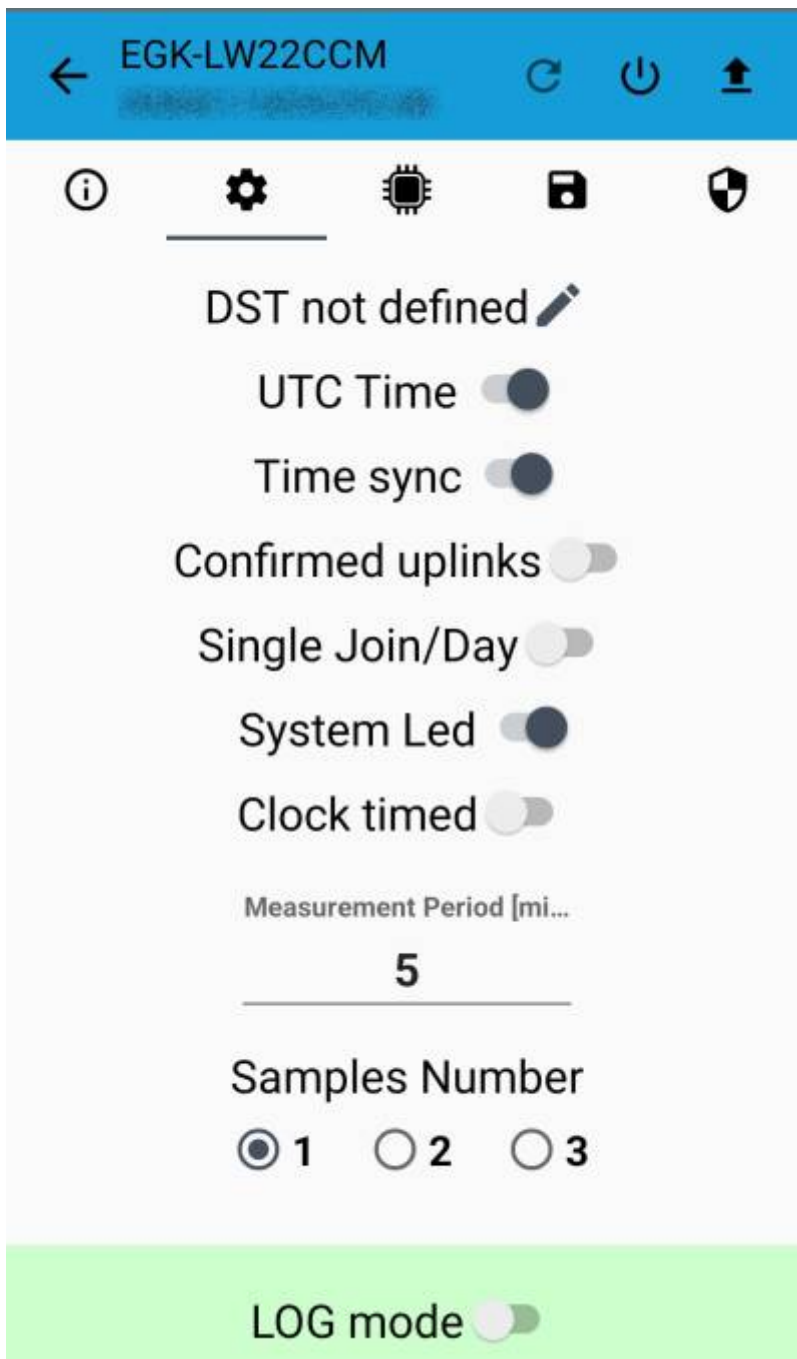

When in **Log mode** , the device makes and save one measure every time interval setted in the Measurement Period setting. When the measure number reaches the Samples Number value, the device will send this measure:

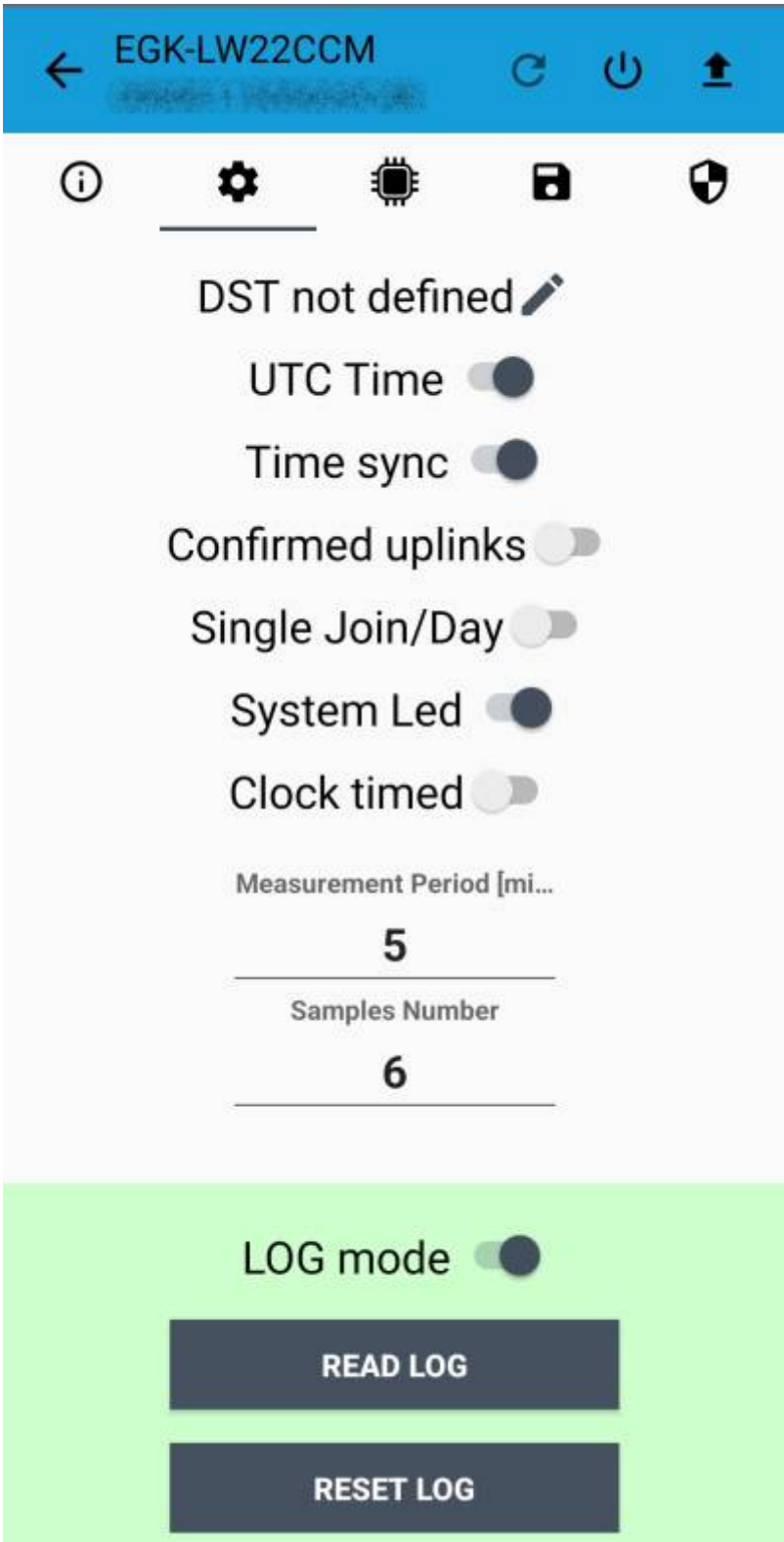

Example: if Samples Number is 10, and Measurement Period is 1, the device will send to the LoRaWAN network 1 uplink every 10 minute. All the measures will be saved in the log file.

Period interval and samples number can be set with App or with downlink command.

3.2 Temperature

3.3 Humidity

3.5 Log data

The EGK-LW22CCM, in Log mode, can store up to 3000 measures.

This is a circular buffer, that means that first starts out empty and when it is full and a subsequent write is performed, then it starts overwriting the oldest data.

Each sample contains these information:

- #: position in the buffer
- Date: timestamp of the measure
- Temperature [°C]: temperature value
- Humidity [%rH]: humidity value
- Battery [%]: battery level
- Sent: **No** if the measure had to be only stored, **Yes** if had to be sent
- Sent OK: **Yes** if the measure was correctly with an uplink, **No** if for some reason it was not possible to send it
- Timesync needed: **Yes** if time synchronization is older than 1 week

Buffer data can be retrieved by LoRaTOOL App:

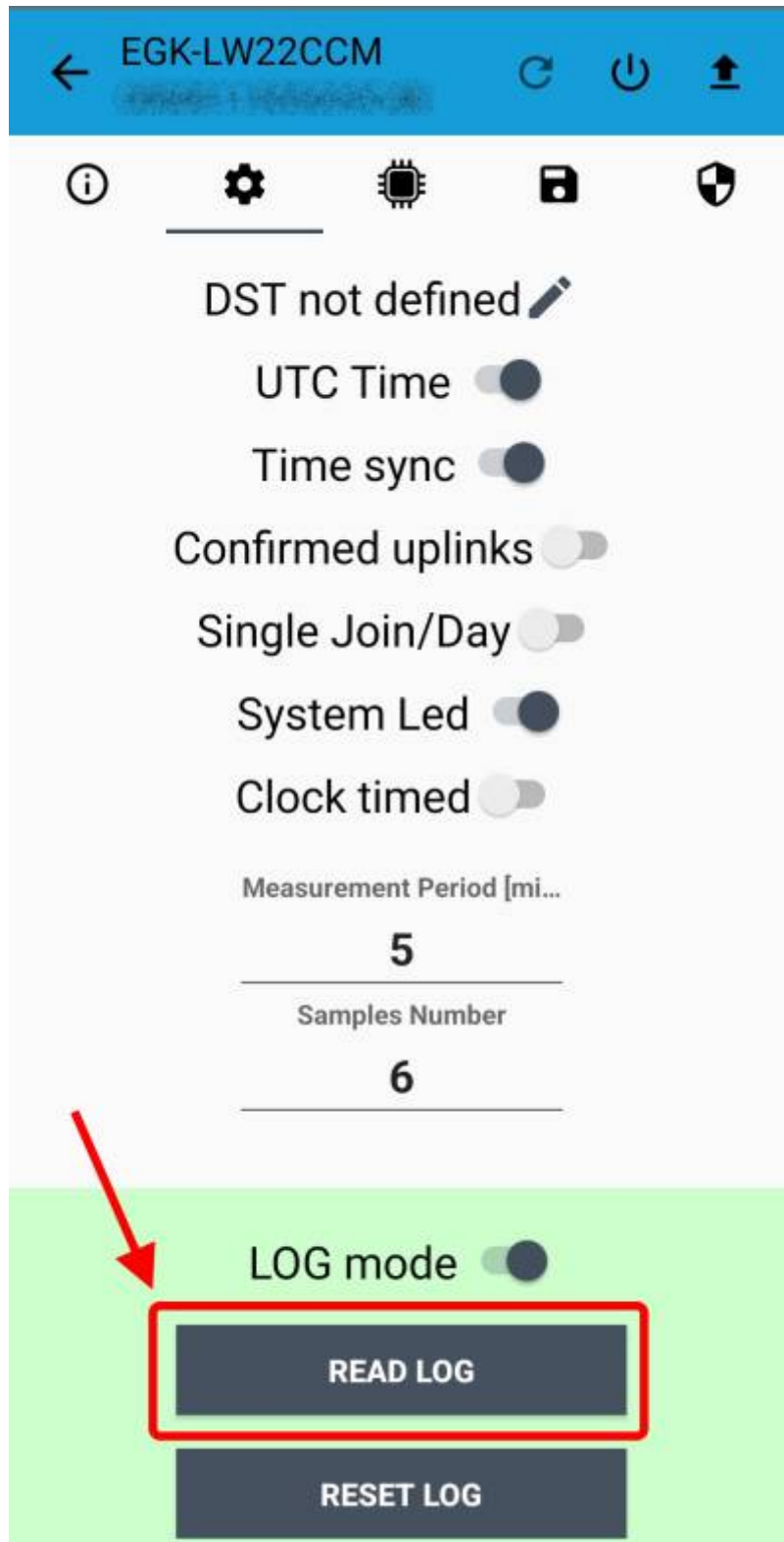

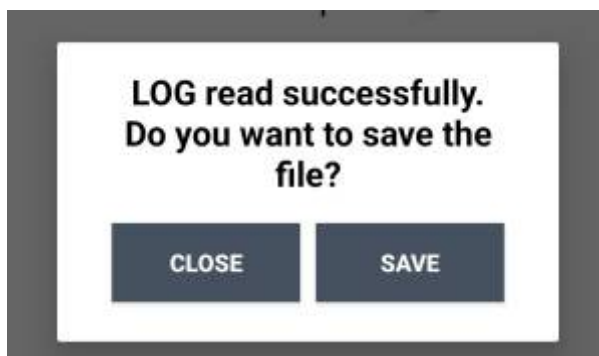

#	Date	Temperature [°C]	Humidity [%rH]	Battery [%]	Sent	Sent OK	Timesync needed
264	2023/09/29 15:02:20	28.16	37.50	95	No	No	No
265	2023/09/29 15:07:18	28.11	37.00	95	No	No	No
266	2023/09/29 15:12:20	28.01	37.00	95	No	No	No
267	2023/09/29 15:17:20	27.96	37.50	95	No	No	No
268	2023/09/29 15:22:20	27.93	37.50	95	No	No	No
269	2023/09/29 15:27:20	28.00	37.00	95	Yes	Yes	No
270	2023/09/29 15:32:20	28.01	37.00	95	No	No	No
271	2023/09/29 15:37:20	28.03	37.00	95	No	No	No
272	2023/09/29 15:42:18	28.07	37.00	95	No	No	No
273	2023/09/29 15:47:20	28.03	37.00	95	No	No	No
274	2023/09/29 15:52:20	28.01	37.00	95	No	No	No
275	2023/09/29 15:57:20	28.04	37.00	95	Yes	Yes	No
276	2023/09/29 16:02:20	28.07	37.00	95	No	No	No
277	2023/09/29 16:07:20	28.12	37.00	95	No	No	No
278	2023/09/29 16:12:20	28.12	37.50	95	No	No	No
279	2023/09/29 16:17:18	27.97	37.00	95	No	No	No
280	2023/09/29 16:22:20	27.89	37.00	95	No	No	No
281	2023/09/29 16:27:20	27.87	37.00	95	Yes	Yes	No

Store data can be also downloaded by LoRaWEB application or with downlinks/uplinks via LoRaWAN networks:

2.28 CCM LOG REQUEST

1.17 T/RH LOG

4 LoRaWAN network

The sensor is compliant with LoRaWAN® **specification 1.0.2, regional 1.0.2b.**



4.1 Activation

The device supports the following activations on a LoRaWAN® network:

1. **NONE**: sensor not activated
2. **OTAA**: the JoinEUI and the AppKey not setted, must be written to the device;
3. **OTAA ENGINKO**: Over the air activation, fixed keys: JoinEUI = 904e915000000001, AppKey on request;
4. **OTAA ENGINKO**: Over the air activation, fixed keys: JoinEUI = 904e915000000001, AppKey on request;
5. **ABP**: requires writing to the device of NwkSkey, AppSkey, DevAddr.

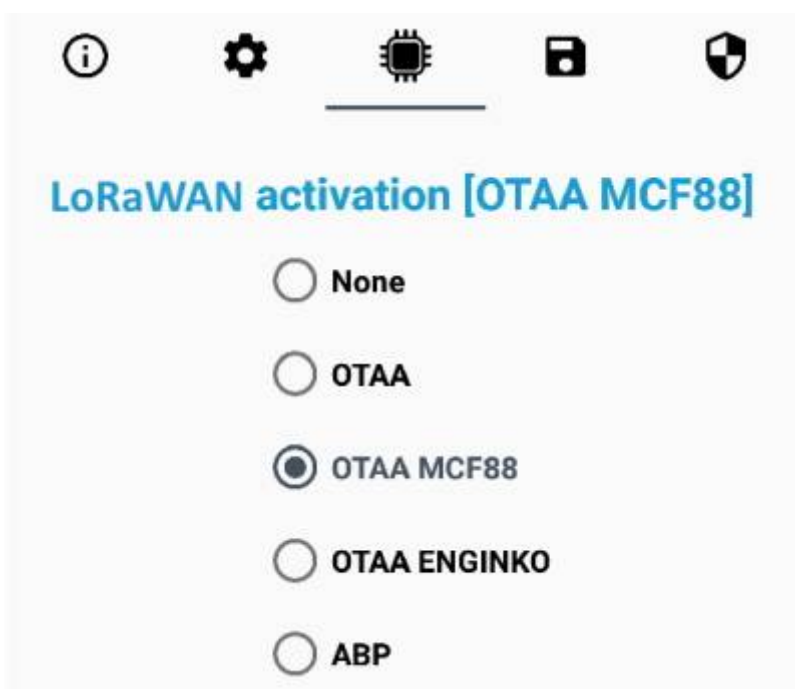

The device exits factory activated with **NONE** mode. On request devices can be shipped already activated.

Note: in **OTAA** AppKey is write only, in reading the field will always be empty, even if set.

4.2 Other settings

Network settings: please keep “Any” settings. Change it only if Objenious network is used (default_ any).

Network type: LoRa syncword can be setted as “private”(0x12) instead “public” (0x34), but the NS must be setted accordingly (default: public).

Band: select the right LoRaWAN ® band settings accodngly to country requirements.

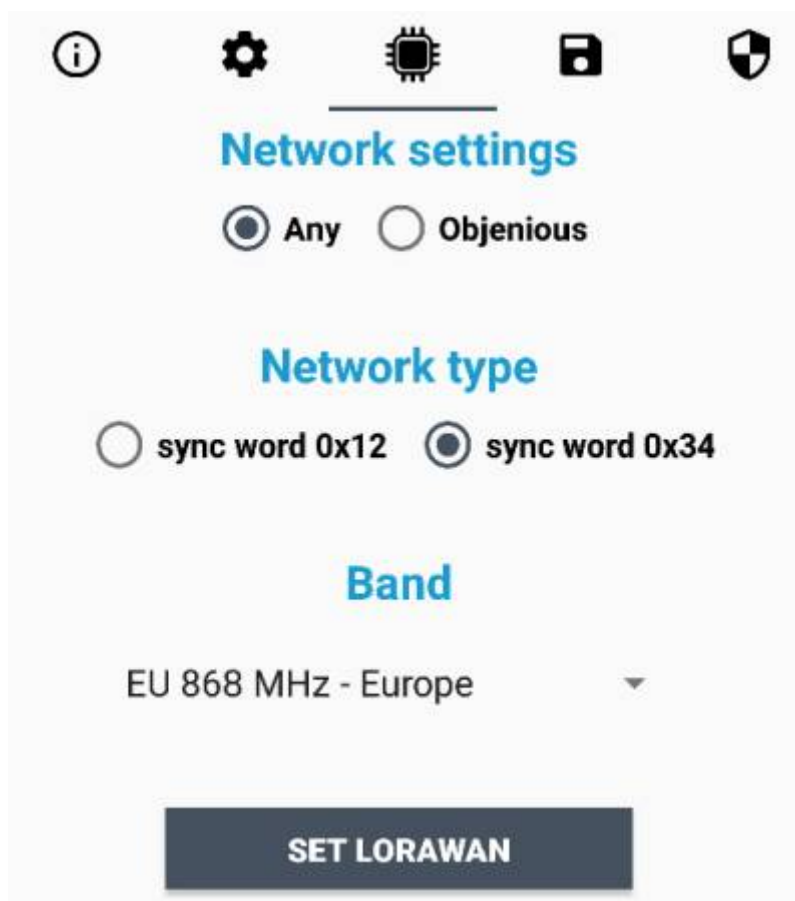

DST: set to change DST (default: none).

UTC time: set to enable UTC(default: disable).

Time sync: set to enable time synchronization request (default: enabled).



Normally sensor asks for a time sync at every power on (uplink starting with 01) or, if enabled, once a week.

If not handled in the right way can cause a unnecessary battery consumption (battery life < 2 years).

Please check chapter 2.1 [DATA FRAME FORMAT](#)

UnConfirmed: set for unconfirmed uplinks (default: confirmed uplink).

Single join/day: set to allow only one join per day (default: multiple join allowed).

System led: set to turn on the system leds (default: system led on).

Clock timed: set to synchronize the measures to the nearest portion of the hour (default: no clock timed).

Example Period: 10 minutes.

- No clock timed

Measures: 10:08, 10:18, 10:28, 10:38, 10:48, 10:58

- Clock timed

Measures: 10:10, 10:20, 10:30, 10:40, 10:50, 11:00

Please be careful: with this setting enabled sensors send uplinks simultaneously.

5 Passwords

The device can be protected by passwords, to avoid unauthorized persons to read data or modify parameters.

As default passwords are equal to 0.

Allowed values range from 0 to 999999999 (only numbers).

To change the passwords, set the new values with the LoRa Tool App:

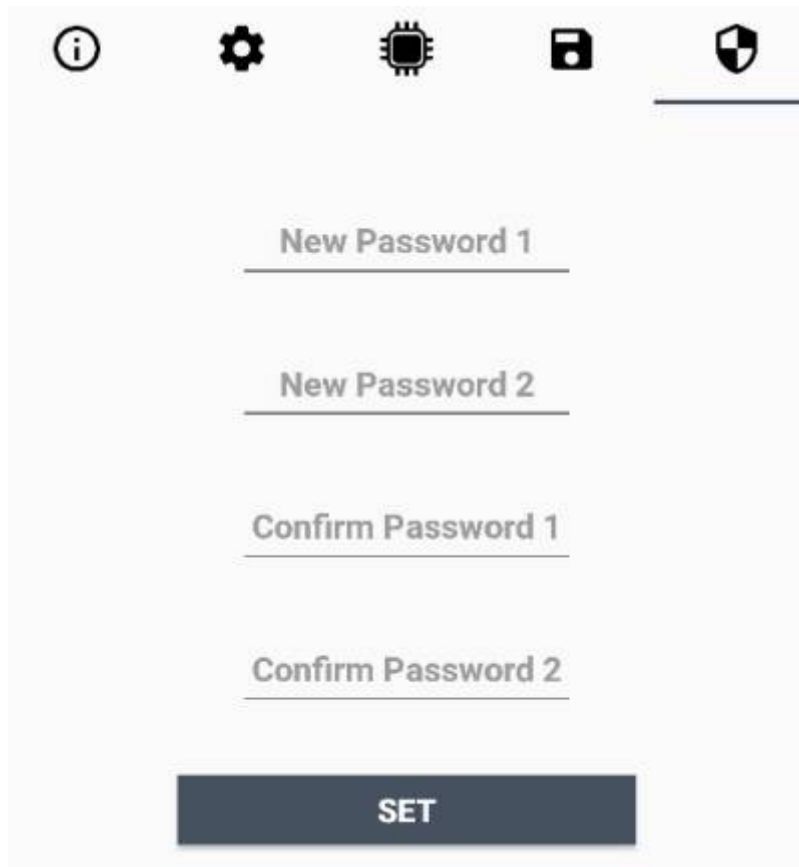

Once the passwords are setted, to gain access from LoRa Tool to the sensor, open the App:

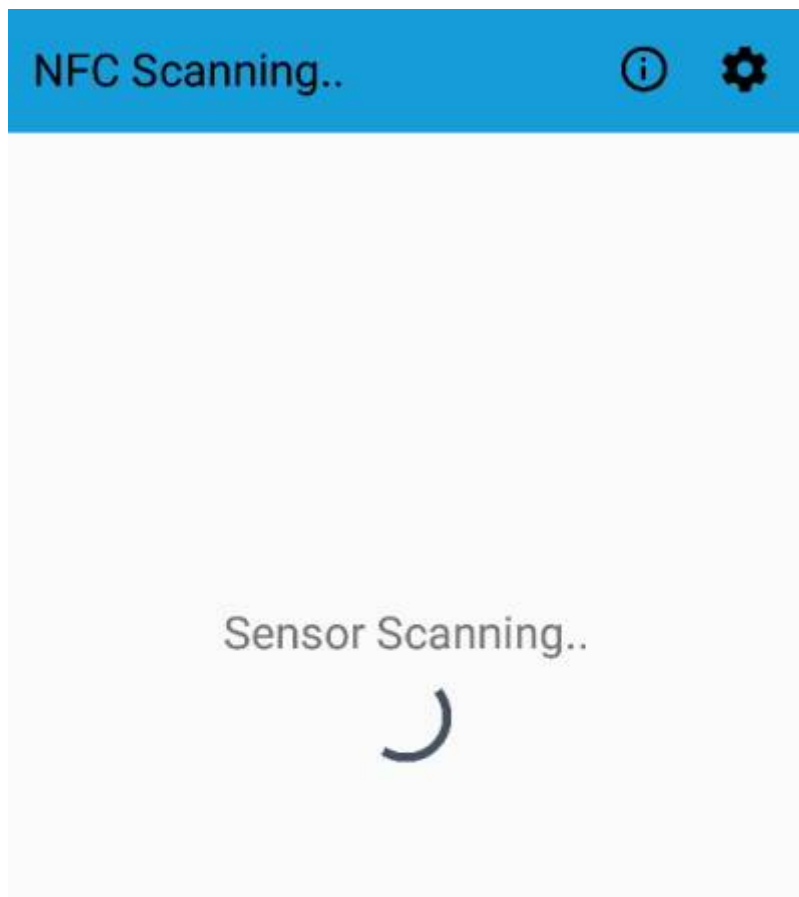

and set the right values before reading from the device:

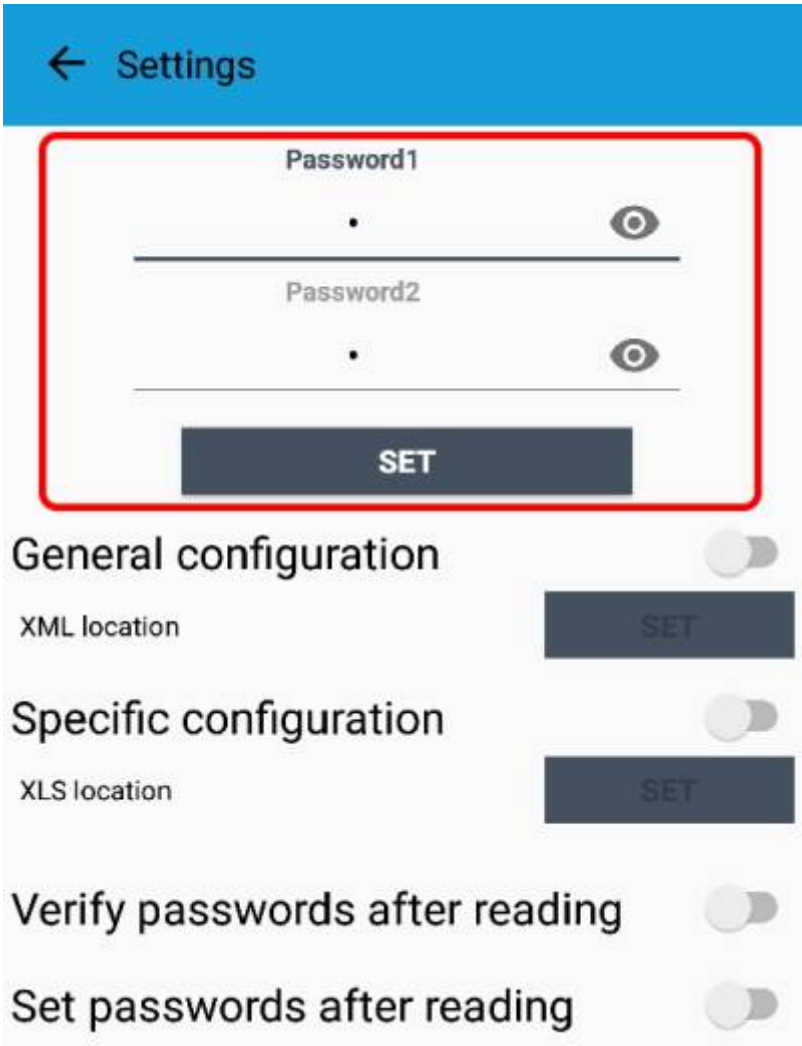

To bring back the sensor to factory default and reset the passwords, a reset code must be requested to enginko (please provide the DevEUI of the sensor when you ask for that code).

6 Configuration file

With LoRa Tool App is possible to configure the device using an XML file, instead to manually adjust the parameters (for details about the file format please ask to enginko). This is very useful especially in case of multiple devices configuration.

With “Save” button an XML file with the actual configuration of the sensor will be generated. This is useful to store or clone the configuration, or to send it to enginko's support if needed.



6.1 Multi devices configuration

With LoRa Tool App is possible to configure many devices in an easy way.

For multi-configuration is needed at least one XML file with the parameters to set.

Settings on this file will be applied to all the sensors.

With an additional XLS file is possible to load different LoRa configuration parameters (Activation Type, AppKey, AppEUI, NetKey, DevAddress, Band, Private option) for each sensor, based on DevEUI.

When the sensor is approached, if one parameter is different from files, the APP will ask you if you want to overwrite.

XLS is prevailing on the XML, so if both files are enabled, if the DevEUI of the device matches one of the DevEUIs in the XLS file, LoRa parameters will be setted from this one..

These configuration can be done in the in the Settings:

- Enable or disable the use of the general configuration by file;
- Enable or disable the use of the specific configuration by file;
- Verify the passwords;
- Writing the passwords.

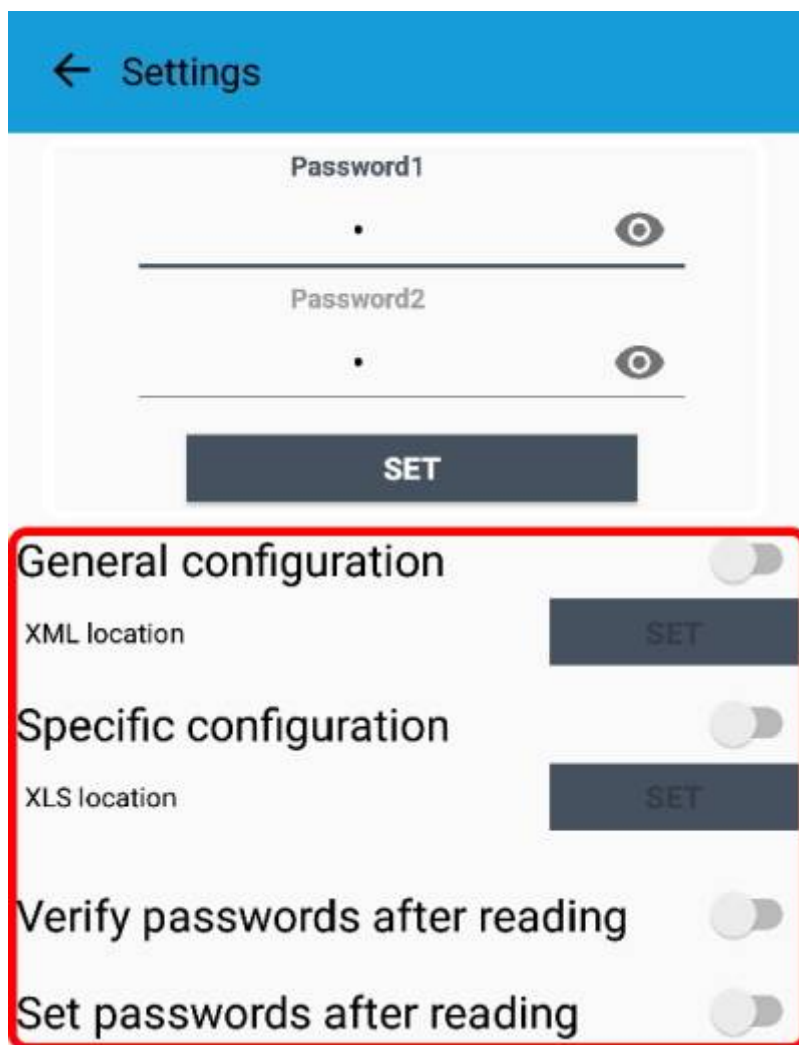

For details on files format please ask to enginko.

7 LoRaWEB Tool

enginko provides, upon free registration, **LoRaWEB** online tool, where for each sensor it is possible to find documentation, javascript examples for parsing, downlink generator and uplink decoder:

[LoRaWEB Tool](https://iot.ENGINKO.cloud/LoRaWeb) (iot.ENGINKO.cloud/LoRaWeb)

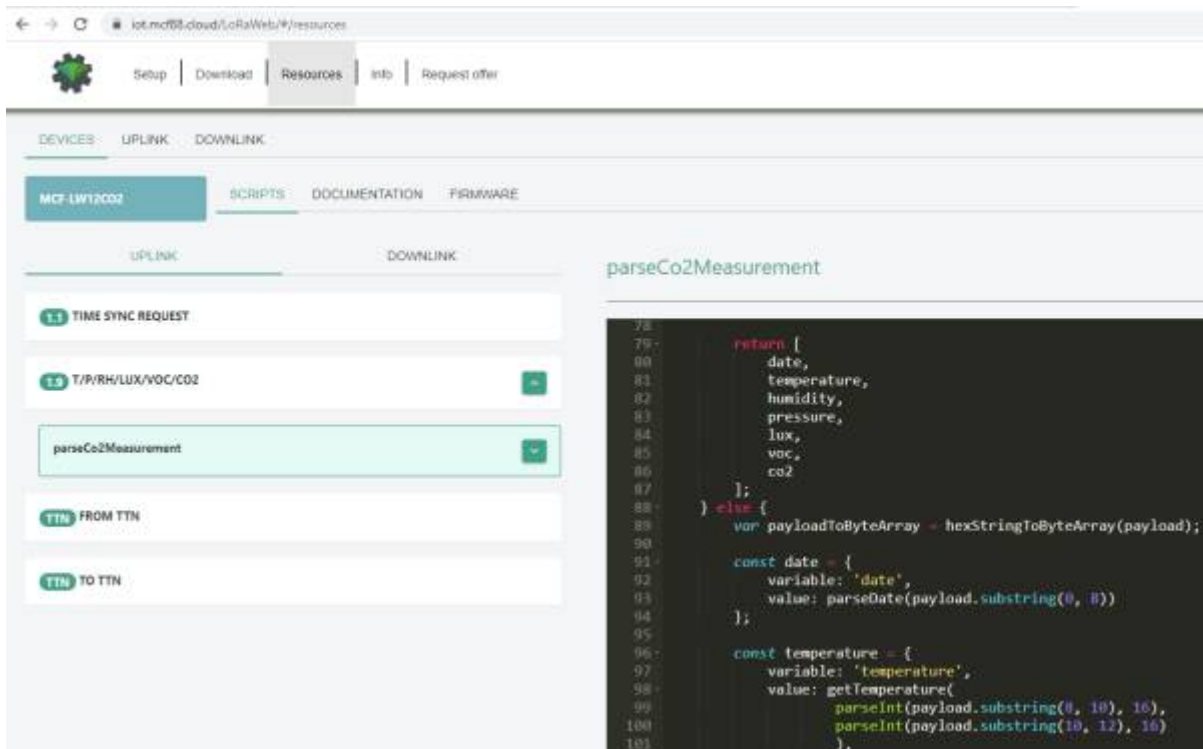
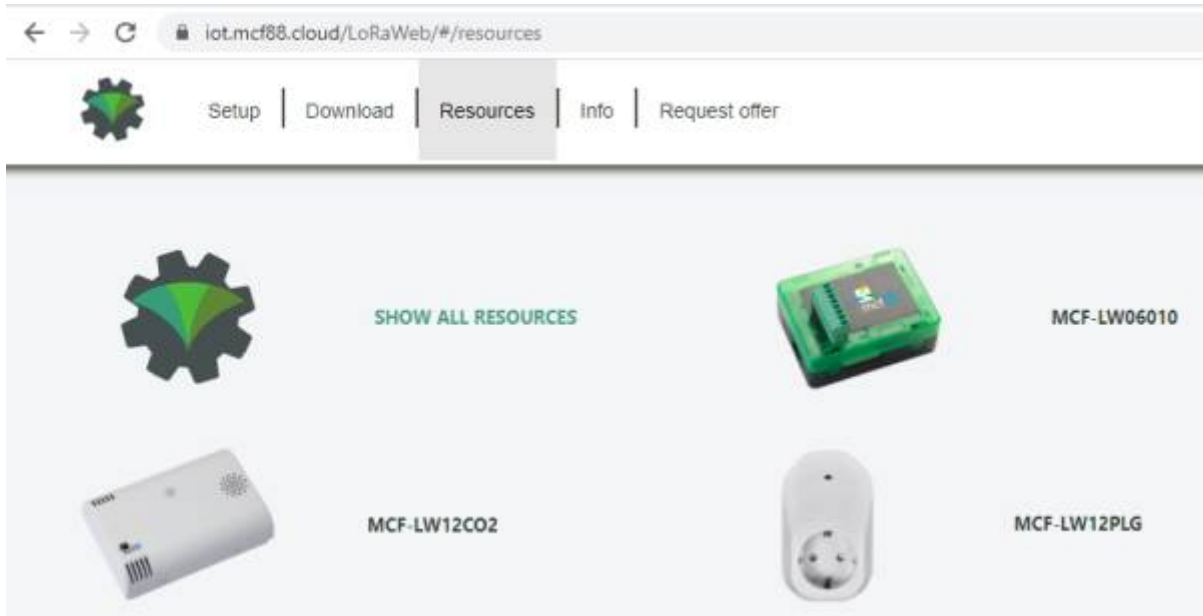

8 Payload

For payload descriptions, uplinks and downlinks format and available commands please refer to this document:

[DATA FRAME FORMAT](#)

9 Ordering code

Code	Description
EGK-LW22CCM	enginko LoRaWAN® outdoor environmental sensor EU863-870
EGK-RAWALL	Wall mount bracket

10 Maintenance



Keep the vent aperture free from dust or cobweb. If necessary, remove obstruction using a low pressure air flow or wipe gently with a cloth.

Avoid liquid presence on the vent.

Do not use any detergent or alcohol to clean the device.

11 Declaration of conformity

Hereby, enginko Srl declares that EGK-LW22CCM complies with the essential requirements and other relevant provisions of Directive 2014/53/EU.

12 Contacts

enginko Srl

Via Roma 3 I-28060 Sozzago (NO)

T : +39 0321 15 93 088

E : info@enginko.com

PEC: enginkosrl@legalmail.it

W: enginko.com

1)

In development

From:

<https://enginko.com/support/> - **enginko.support.center**

Permanent link:

https://enginko.com/support/doku.php?id=manual_egk-lw22ccm&rev=1707899817

Last update: **2024/02/14 09:36**

