

# Table of Contents

- EGK-LW20W00 Operating Manual** ..... 1
- 1. Description** ..... 1
- 2. Overview** ..... 2
  - 2.1 Technical data ..... 2
  - 2.2 Installation ..... 2
  - 2.3 Power ON/OFF ..... 9
  - 2.4 System leds ..... 10
  - 2.5 Battery ..... 11
  - 2.6 Firmware update ..... 14
- 3. Measures** ..... 15
  - 3.1 Level settings ..... 16
  - 3.2 Input ..... 25
- 4 LoRaWAN network** ..... 26
  - 4.1 Activation ..... 26
  - 4.2 Other settings ..... 27
- 5 Passwords** ..... 30
- 6 Configuration file** ..... 32
  - 6.1 Multi devices configuration ..... 33
- 7 LoRaWEB Tool** ..... 34
- 8 Payload** ..... 35
- 9 Ordering code** ..... 35
- 10 Declaration of conformity** ..... 35
- 11 Contacts** ..... 35





## EGK-LW20W00 Operating Manual

### Important safety information



Read this manual before attempting to install the device! Failure to observe recommendations included in this manual may be dangerous or cause a violation of the law. The manufacturer will not be held responsible for any loss or damage resulting from not following the instructions of this operating manual.

- Do not dismantle or modify in any way.
- The device is not intended to be used as a reference sensor, and Angel4Future Srl will not be held liable for any damage which may result from inaccurate readings.
- Avoid mechanical stress
- Do not use any detergent or alcohol to clean the device.
- Risk of explosion if the battery is replaced with an incorrect type.
- Risk of explosion if the battery pack is subjected to a short circuit.
- Risk of explosion if the battery is burned or placed near high heat sources.
- Risk of explosion if batteries are crushed, punctured or cut.
- Do not expose batteries to contact with liquid substances.

### Disposal information for users



**Pursuant to and in accordance with Article 14 of the Directive 2012/19/EU of the European Parliament on waste electrical and electronic equipment (WEEE), and pursuant to and in accordance with Article 20 of the Directive 2013/56/EU of the European Parliament on batteries and accumulators and waste batteries.**

The barred symbol of the rubbish bin shown on the equipment indicates that, at the end of its useful life, the product must be collected separately from other waste.

Please note that the lithium batteries must be removed from the equipment before it is given as waste and disposed separately. To remove the batteries refer to the specifications in the user manual. For additional information and how to carry out disposal, please contact the certified disposal service providers.

## 1. Description

The EGK-LW20W00 is a battery powered sensor intended for waste level measurement up to 1.5 meters. The device sends collected data over the LoRaWAN® network.



## 2. Overview

### 2.1 Technical data

- CPU ARM Cortex M4
- Class A LoRaWAN® 1.0.2 , EU868
- OTAA/ABP activation
- Level range 165 ÷ 1500mm, resolution 1mm, accuracy TBD
- Field of View: ±15°
- Non contact level detection up to 1.5mt
- Internal temperature measurement (+/- 1°C typ, +/- 2°C max).
- Embedded antenna
- Magnetic start-up
- Time interval based or thresholds based uplink
- Embedded accelerometer for tilt status
- Primary battery with no harmful substances, replacement possible
- Pole or surface mount
- 5 years life time with SF12 and max Tx power, 48 Uplinks messages per day
- Transmission @ 868 MHZ, 14dBm max.
- BLE 5.0 interface for configuration, data reading and FW upgrade
- Remote configuration
- Storage temperature -30°C ÷ +80°C
- Working temperature -30°C ÷ +65°C
- Dimensions: 64.5×58.5×39mm
- Protection grade: IP67
- Weight: 90g

### 2.2 Installation

To ensure correct operation and reliable and consistent level measurements, install the EGK-LW20W00 sensor on the lid interior. Screws are provided.

The device must be placed where the LoRaWAN® signal coverage is good (SF = 7 optimal, SF = 12 weak).

The device measures the distance to the closest target on its field of view. It works with different waste materials like organic, glass, paper, plastic, residual waste.

The measure is performed periodically according to parameter Period [min].



Alternatively, the sensor can be mounted to overflow detection on the side of the lid:

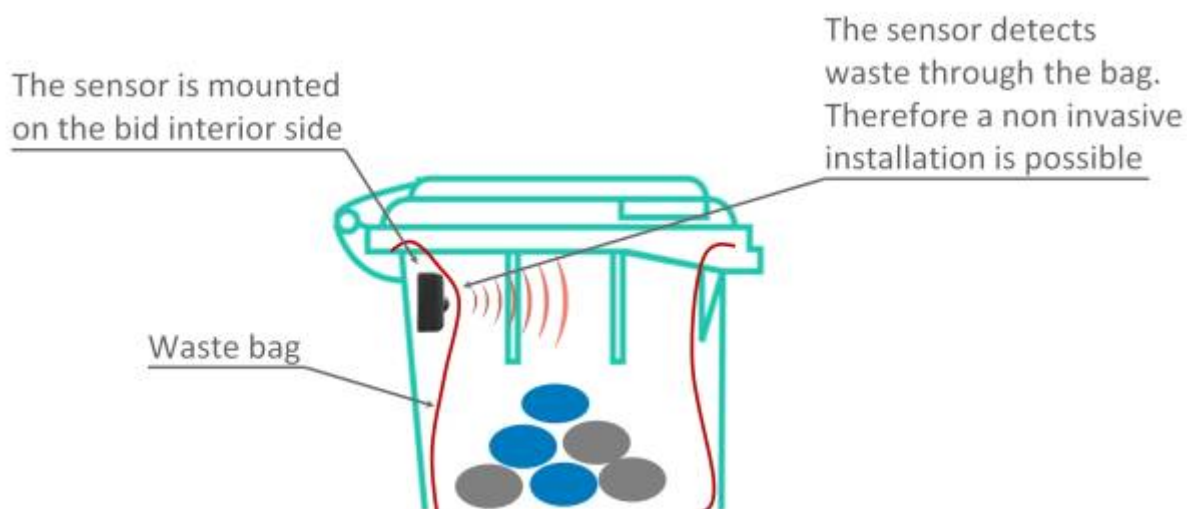

In this case, level parameters need to be modified.

**Custom brackets available on request.**

### 2.2.1 Bin lid or side mount

For mounting onto the lid or side of the bin, use the provided screws and spacers:

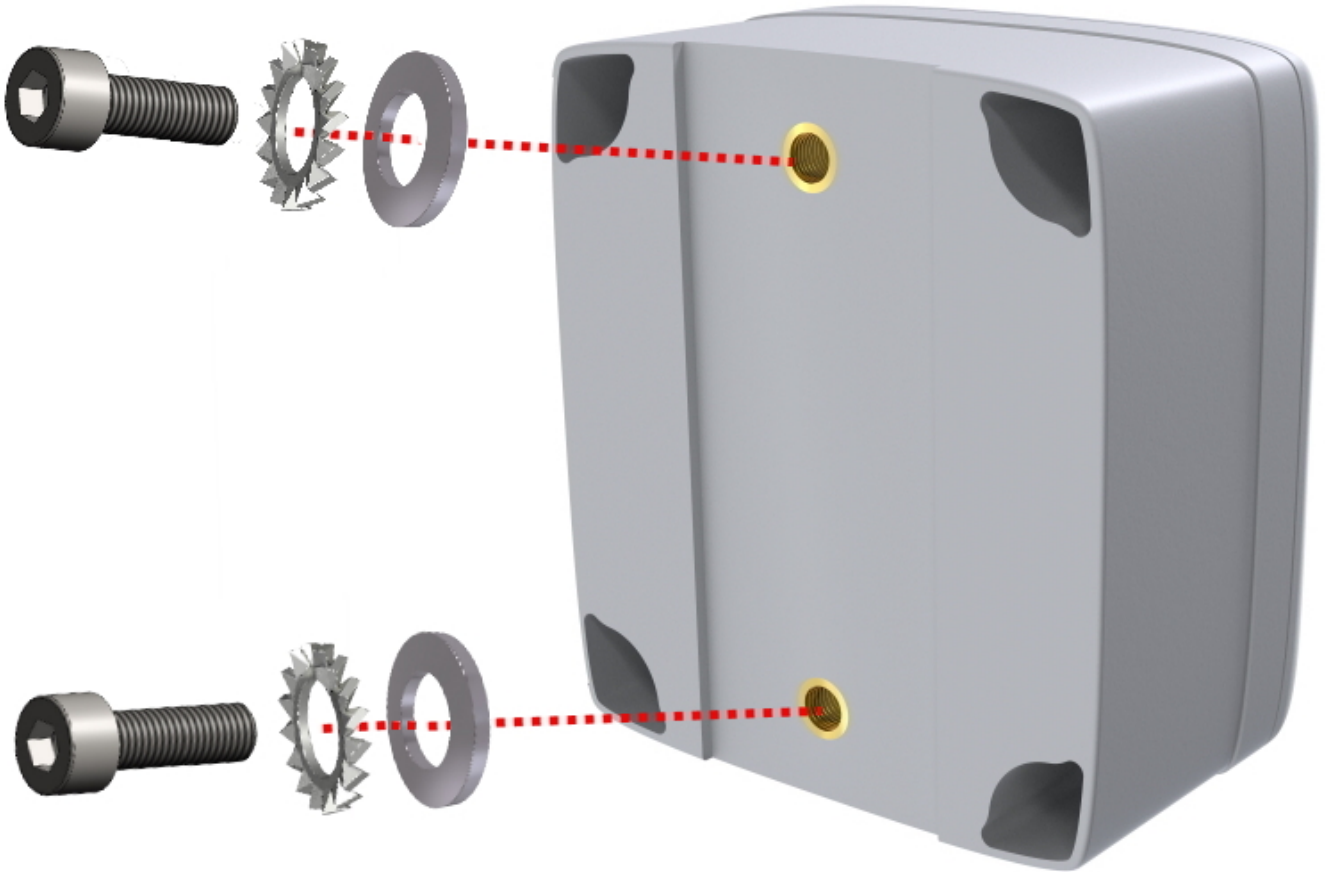

#### 2.2.1.1 Lid mount examples

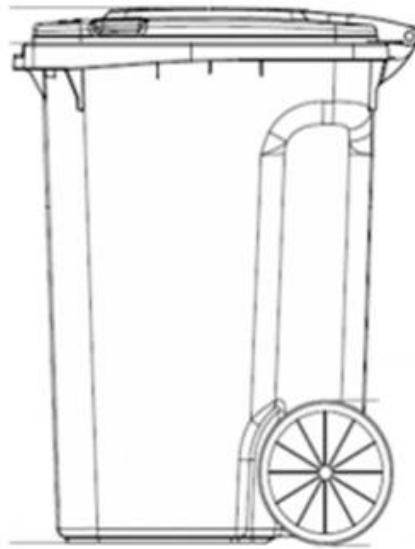

120l  
240l  
360l

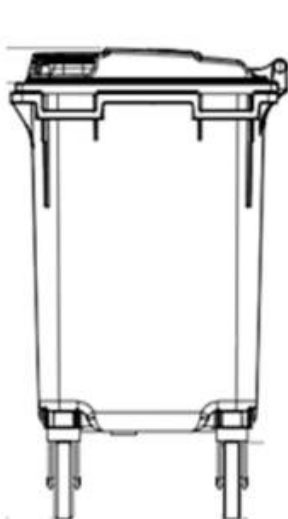
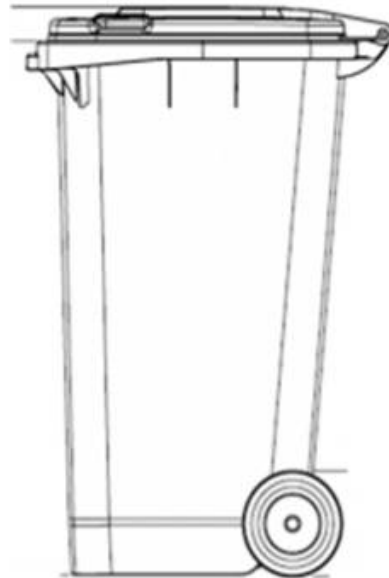

660/770l

### 2.2.2 Wall mount

For mounting onto wall, use the optional wall mount bracket **EGK-RAWALL**:

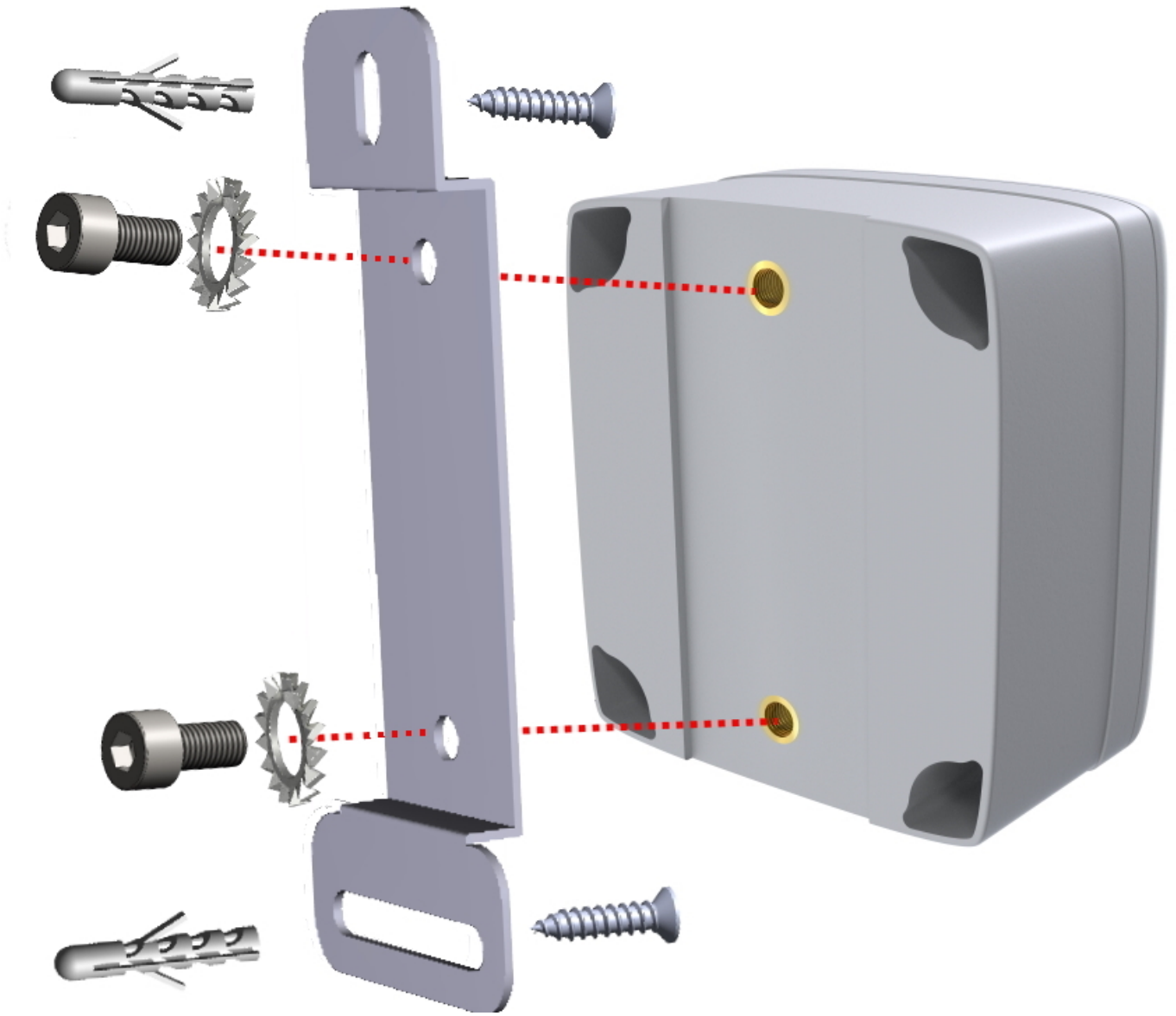

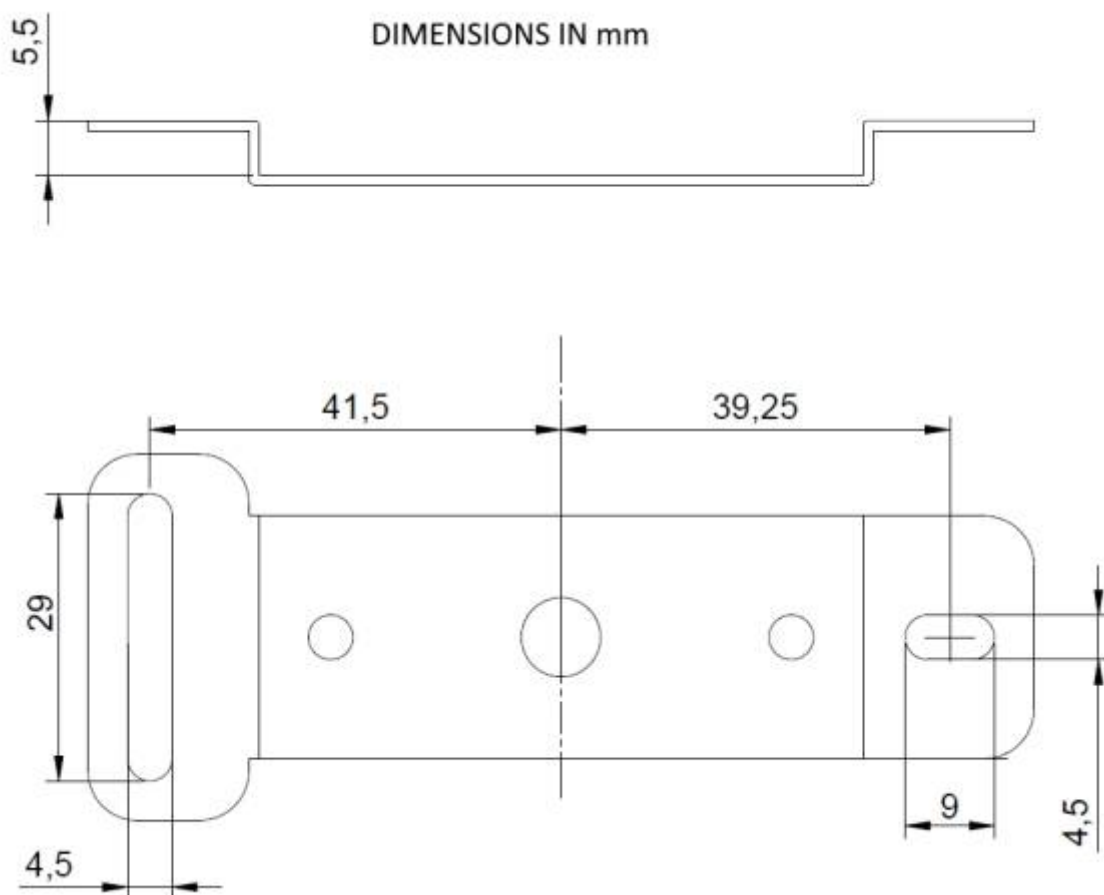

### 2.2.3 Pole mount

For installation on poles, pillars or posts use the included bracket and fasteners:

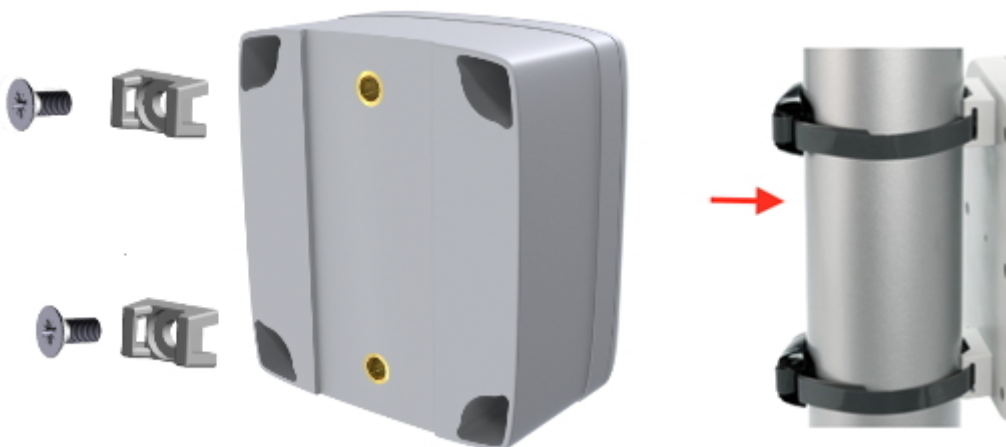

### 2.2.4 LoRa Tool

To deploy the sensor, download the latest **LoRa Tool** Android App to setup LoRaWAN® credentials and other preferences :



### 2.2.5 Connection

Enable the Bluetooth on the smartphone and open the App:

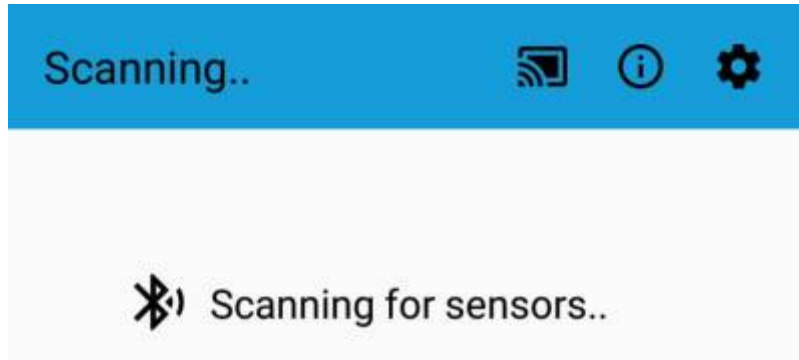

once the sensors list appears (as BLE MAC address), select the sensor you need to configure:

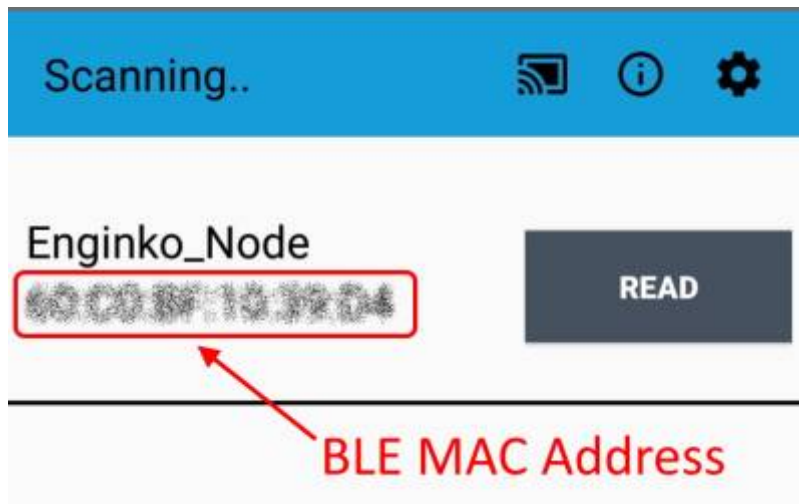

and read it:

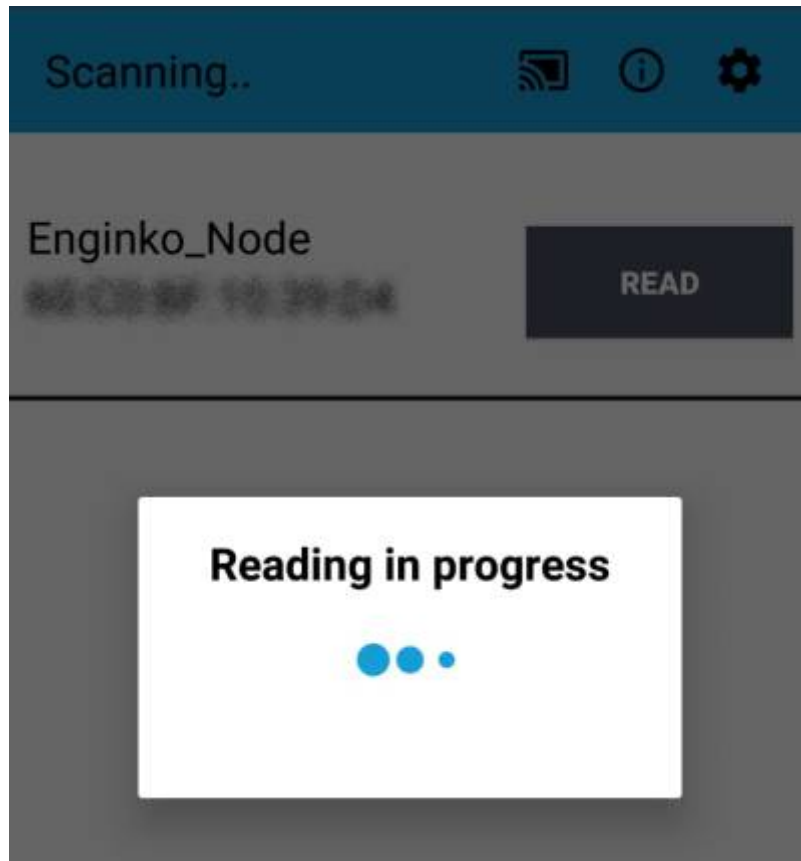

### 2.3 Power ON/OFF

The sensor is shipped completely off to prevent battery consumption during storage. It is therefore necessary to carry out a first power-on prior to commissioning.

To power on the sensor: lay the magnet at the bottom of the provided tool into the area shown in the figure:

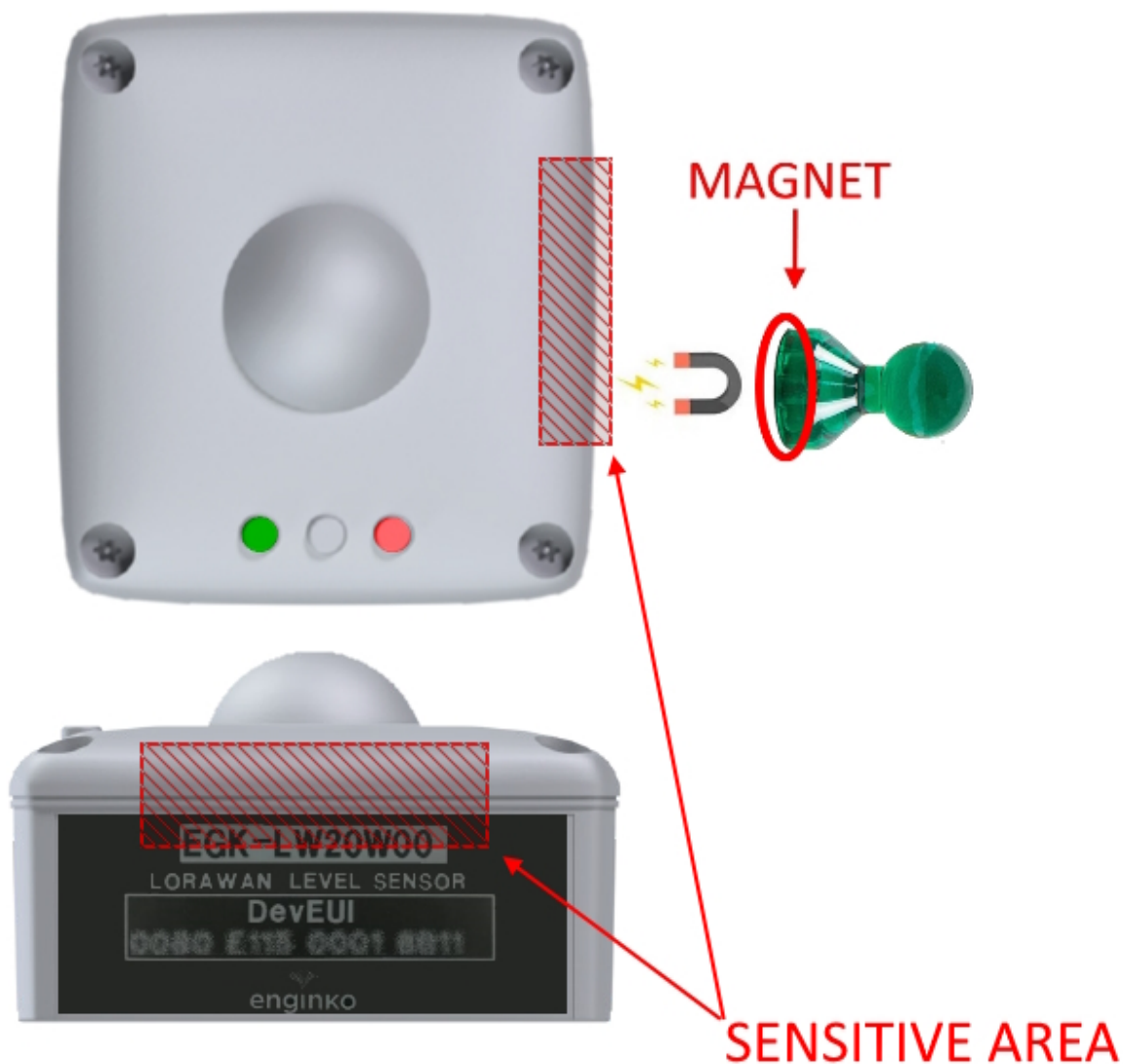



Successful power on is signaled by the flashing of the 2 LEDs.

In case of long period of inactivity, if necessary, is possible to shut-off again the sensor to prevent battery consumption, via downlink or with LoRa Tool App:



## 2.4 System leds

LoRaWAN® not configured			Slow flashing
-------------------------	---	---	---------------

Joining		Quick flashing
Sending		Quick flashing

## 2.5 Battery

This sensor contains lithium battery, which must be disposed of separately.

EGK-LW20W00 is provided with a battery pack:

Code	Description
EGK-1S2PCR	4800mAh battery pack

Replacement battery only available from Angel4Future.

This is the estimated battery life (in **years**) in the worst conditions:

	10min reading	15min reading	30min reading
<b>SF12</b>	2	3	5
<b>SF7</b>	4	5	8

### 2.5.1 Battery replacement

- remove the front panel of the sensor with a small screwdriver:

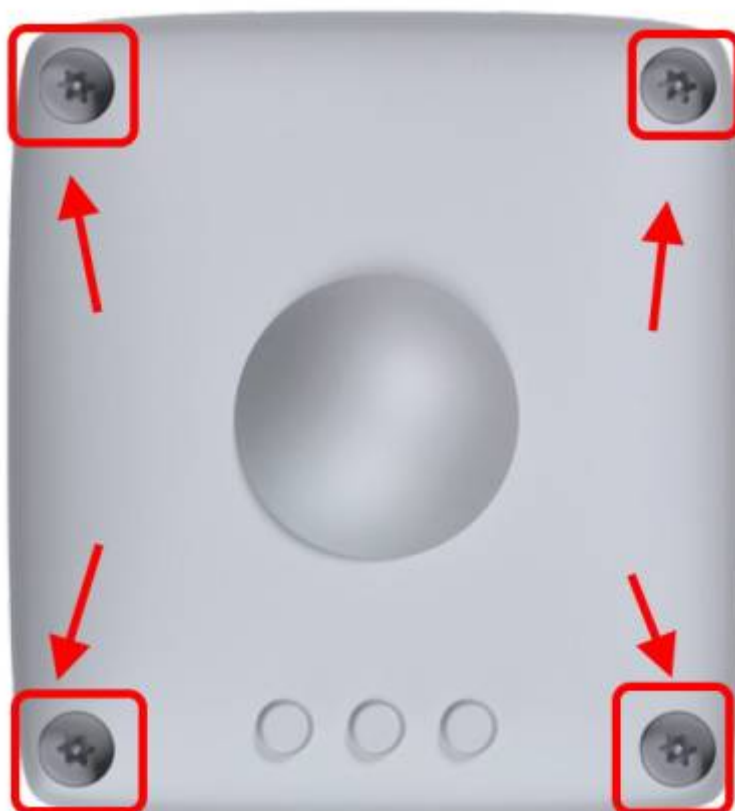

- remove the PCB batteries pack from the main board (PCB board is secured with two small screws):

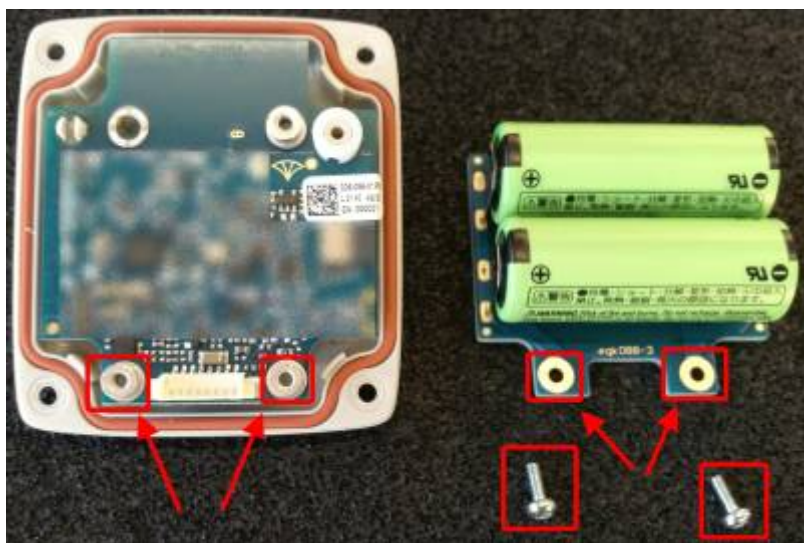

- Place the new PCB batteries pack and put them in place with the screws:



- Place the front panel and fix it with the 4 screws.

After the batteries replacement, internal counters need to be resetted.

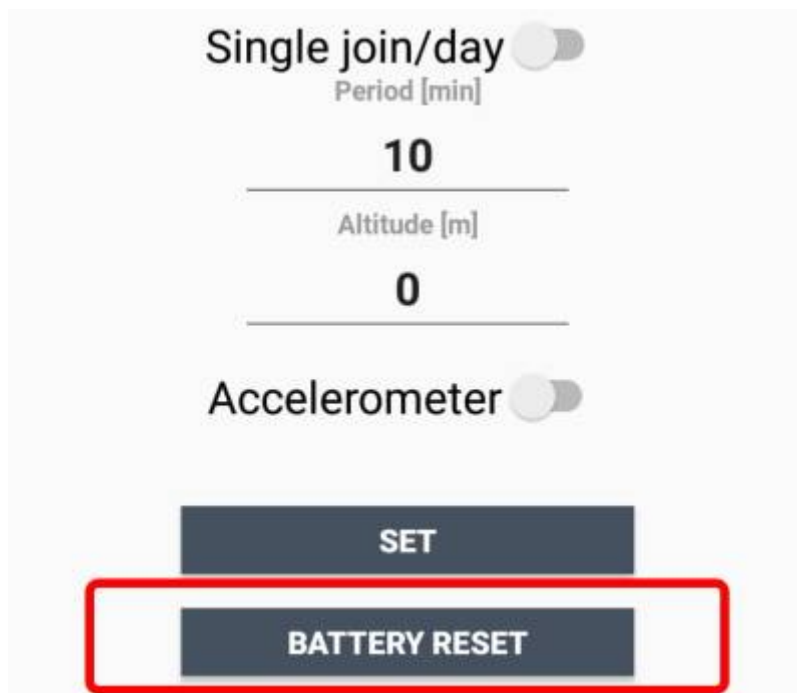

To perform the operation, you need a unique reset code that must be requested to Angel4Future (please provide the DevEUI of the sensor when you ask for that code):

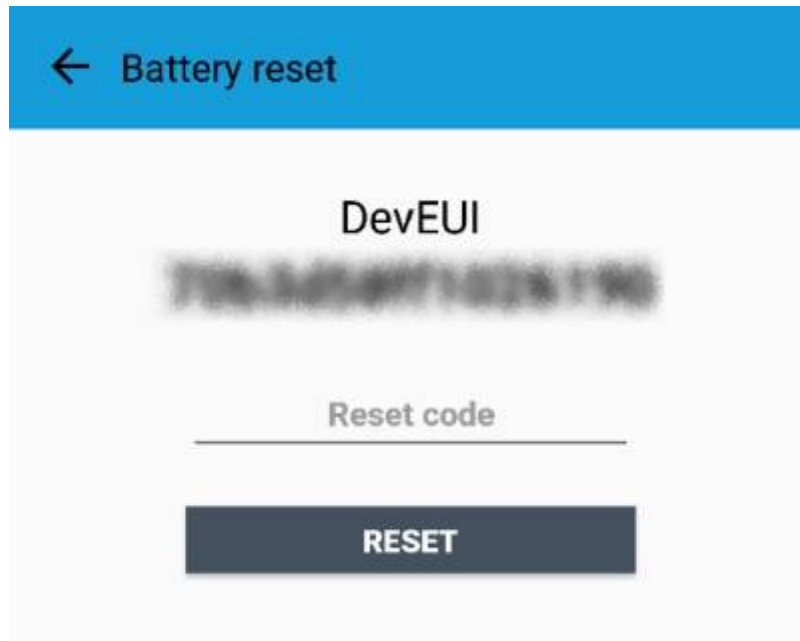

At the end of the procedure the battery level displays 100%.

## 2.6 Firmware update

Download the latest firmwares available on the smartphone:

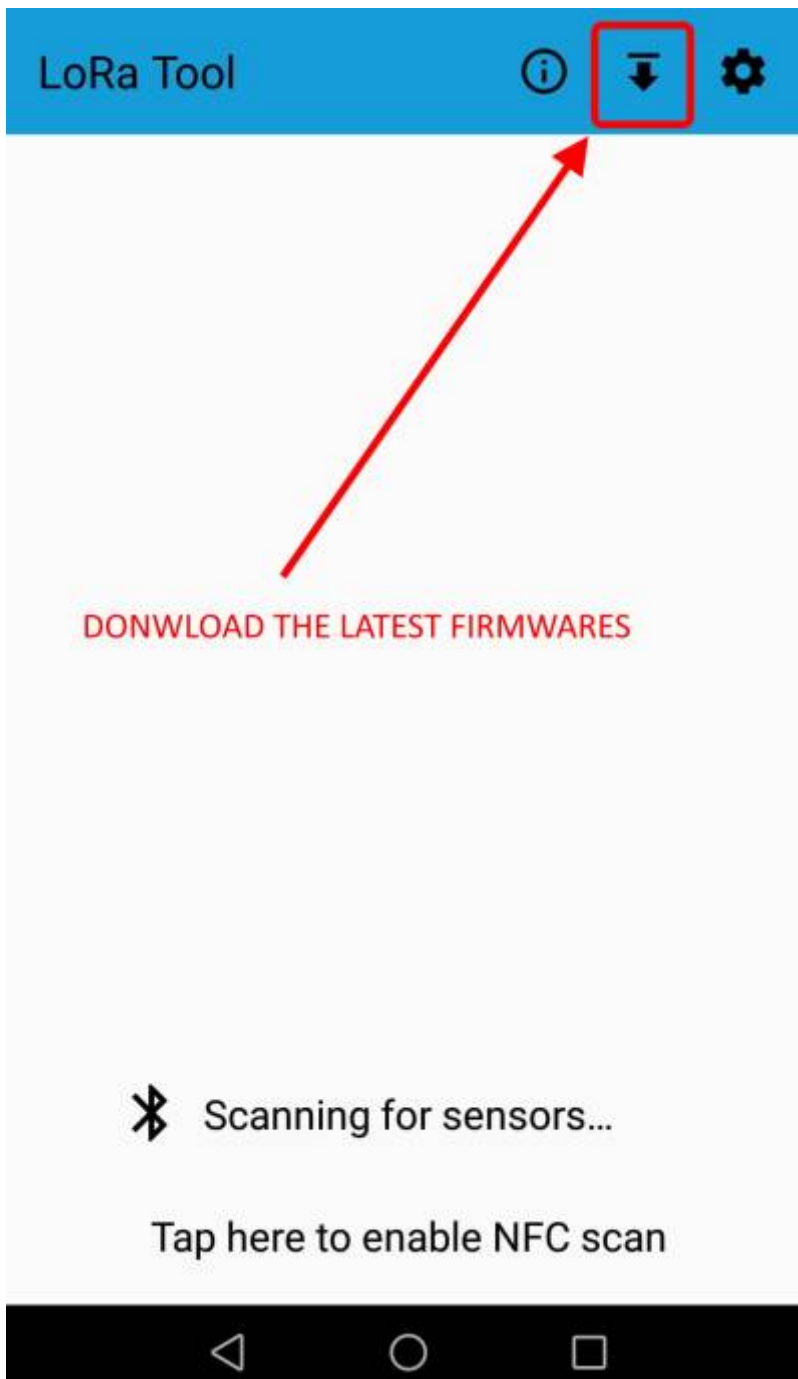

Upload it with LoraTool App:



### 3. Measures

On each reading of the sensor by LoraTool, the measured distance is shown on the main page:



The temperature value is measured inside the sensor.

Once provisioned on a LoRaWAN® network, the device sends the distance, temperature, filling level & timestamp to the server via uplink.

### 3.1 Level settings

Level measurements are carried out according to few parameter settings. A target over the defined range cannot be detected. Read and write of parameters can be done using LoRaTool App. They have a default value and can be modified to be tailored on the specific use case.

Meaning of parameters is related to following diagram. The “REFERENCE” (distance=0mm) is the top surface of the sensor:

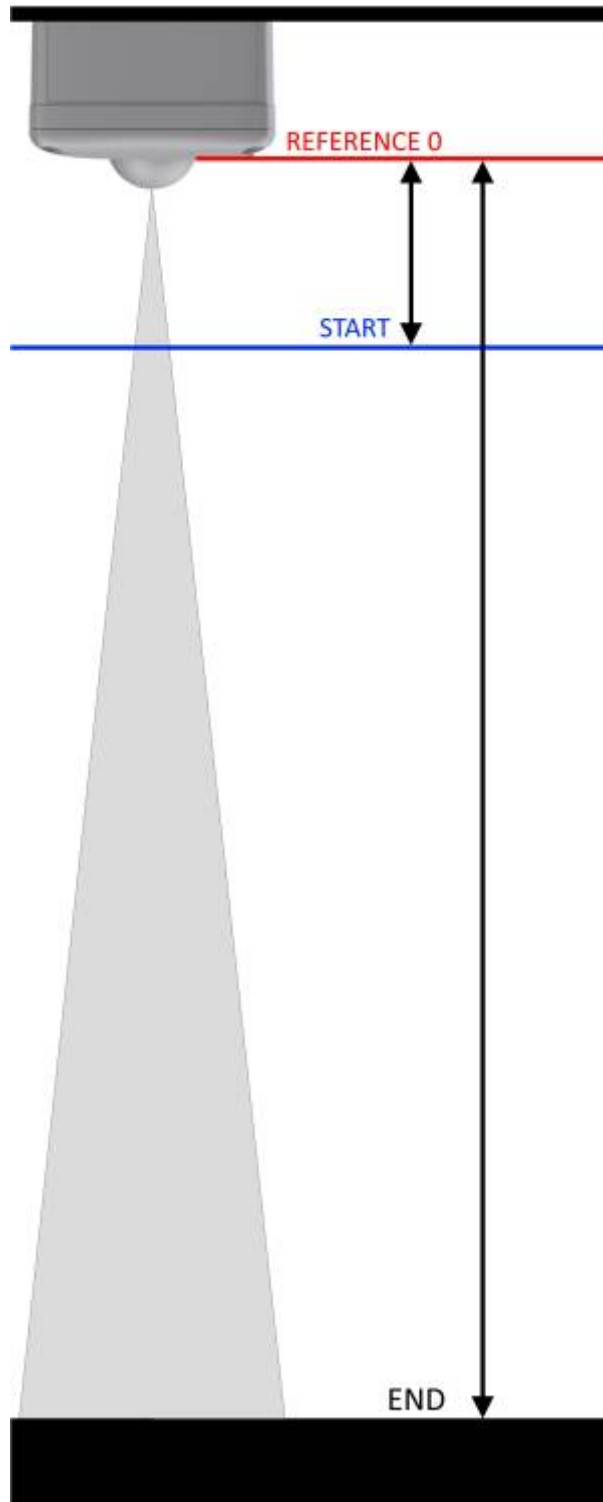

### 3.1.1 Start [mm]

Starting point of the measurement (in mm from “REFERENCE” point).

Values can be set from 140 to 1360:

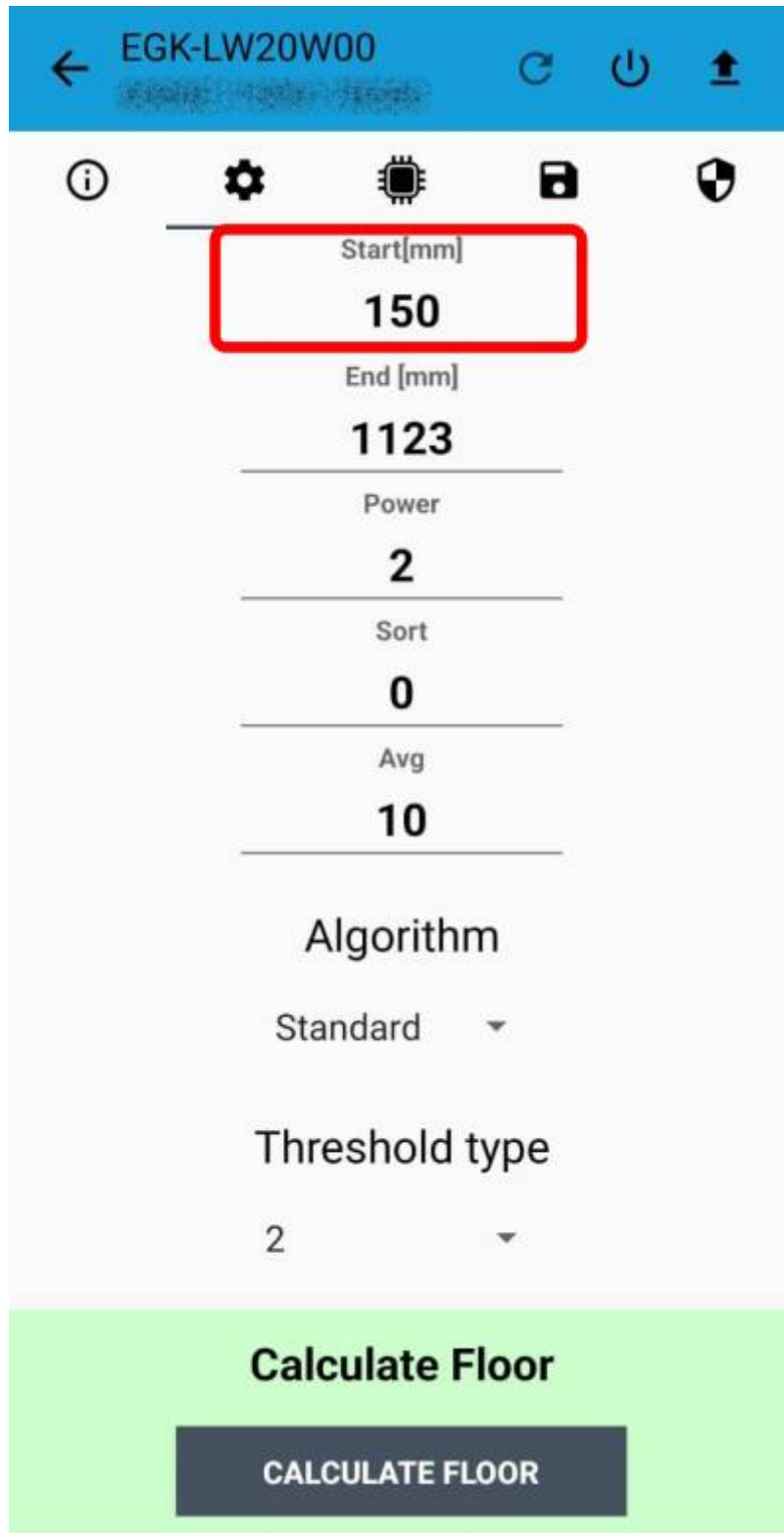

Default: 150

A target within the “Start [mm]” distance will result at a “Start” distance.

The “Start [mm]” value is also related to other level parameters. Contact Angel4Future in case of assistance.

### 3.1.2 End [mm]

Range of measure (in mm, from "Reference" point).

Values can be set from 0 to 2000:

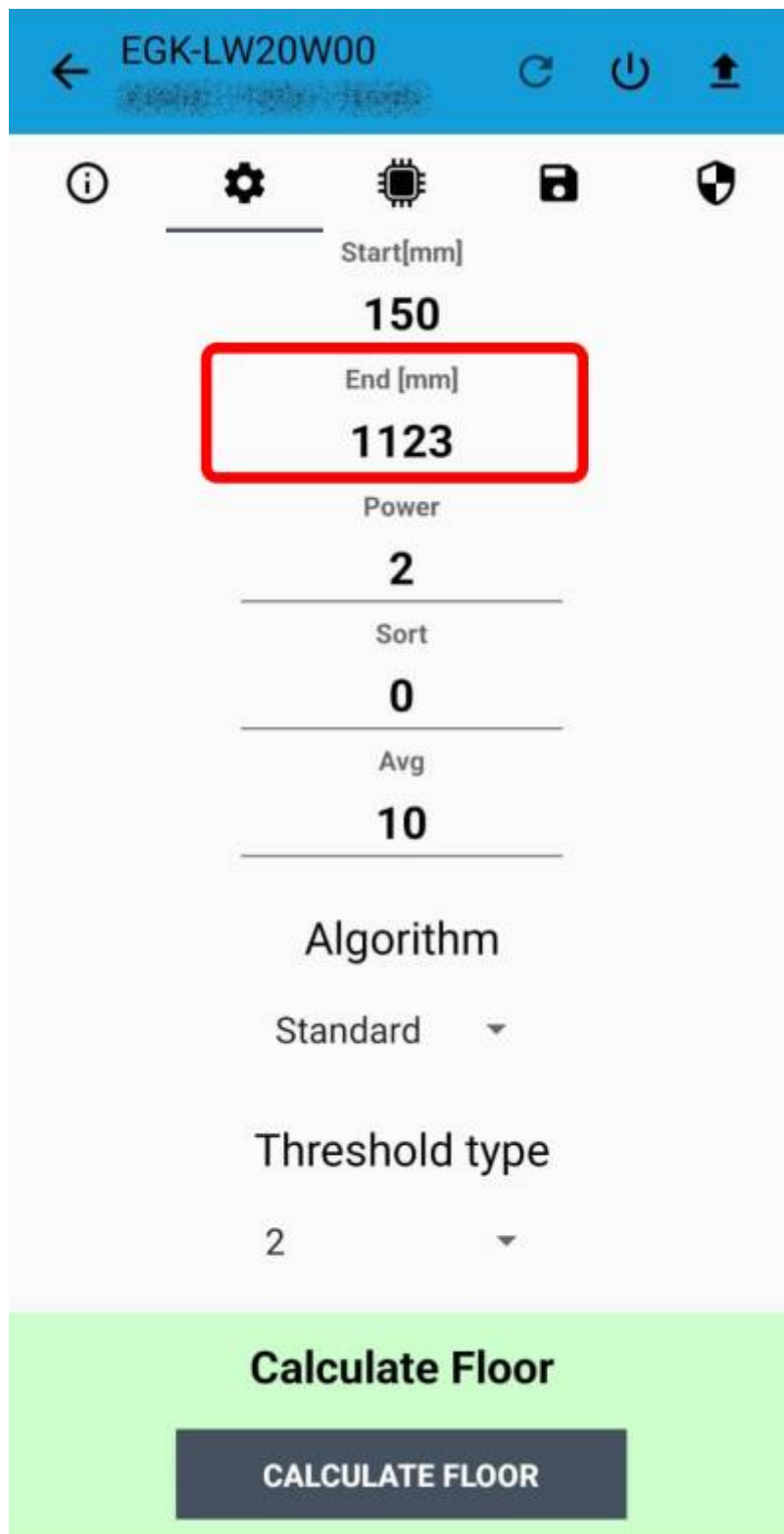

Default: 1010

The END value can be inferred from a physical measurement of obtained from the sensor itself using the function "Calculate Floor"

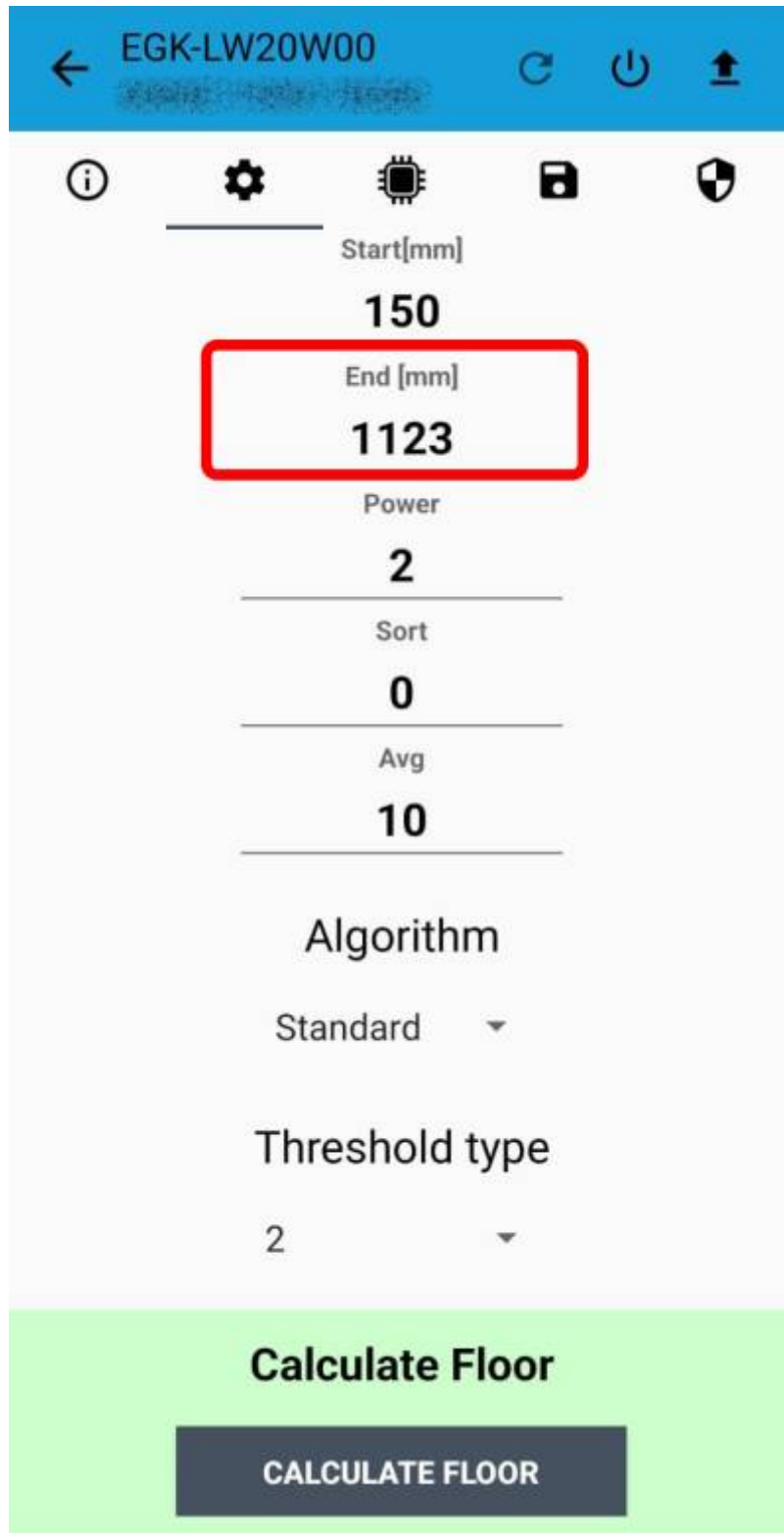

After executing this function, perform a new reading and validate the value obtained.

### 3.1.3 Power

Power setting for target detection.

Values can be set from 1 to 5:



Default: 2

### 3.1.4 Sort

Sorting type.

Values can be set from 0 to 3:

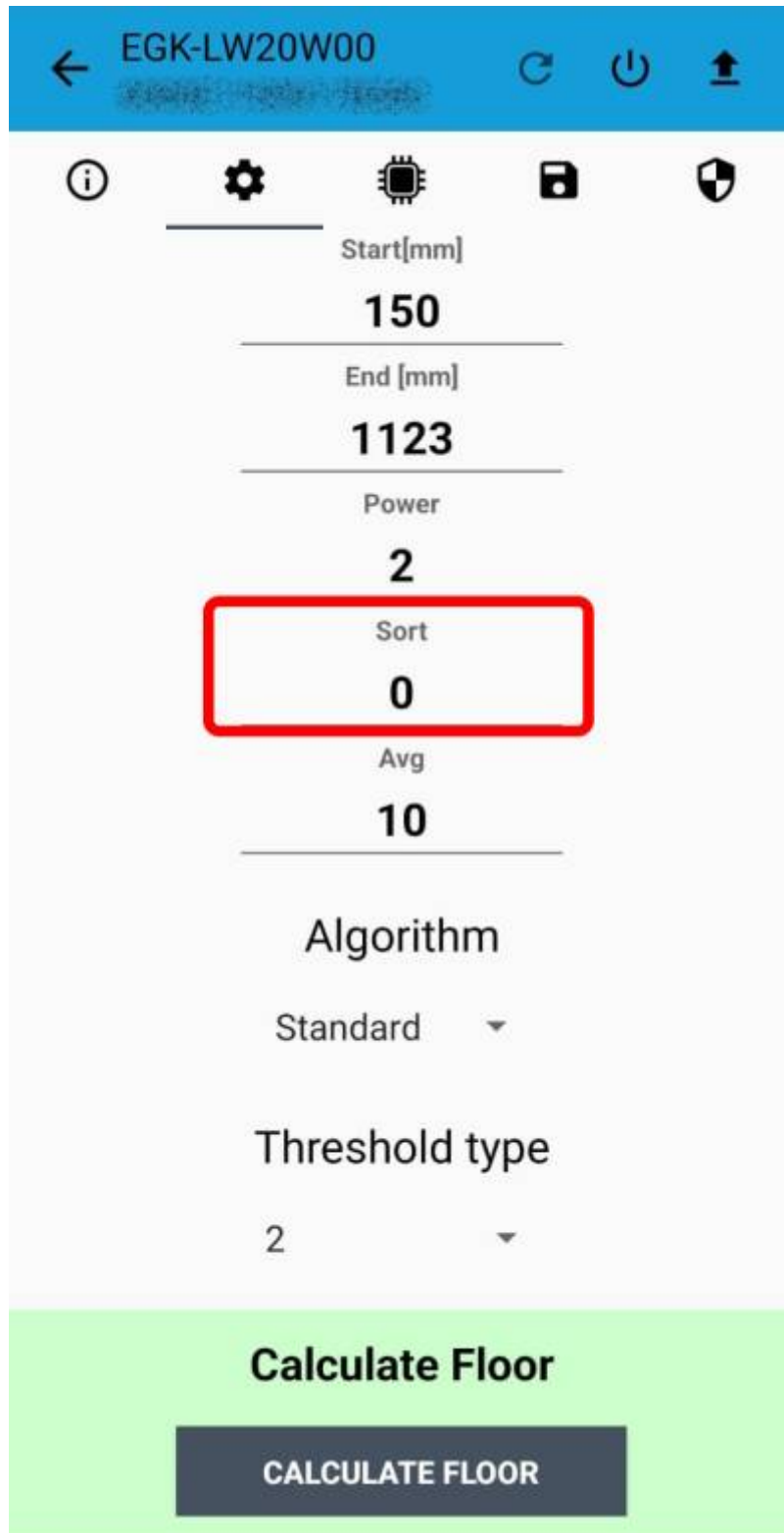

Default: 0

### 3.1.5 Avg

Number of samples for each measure

Values can be set from 1 to 100:

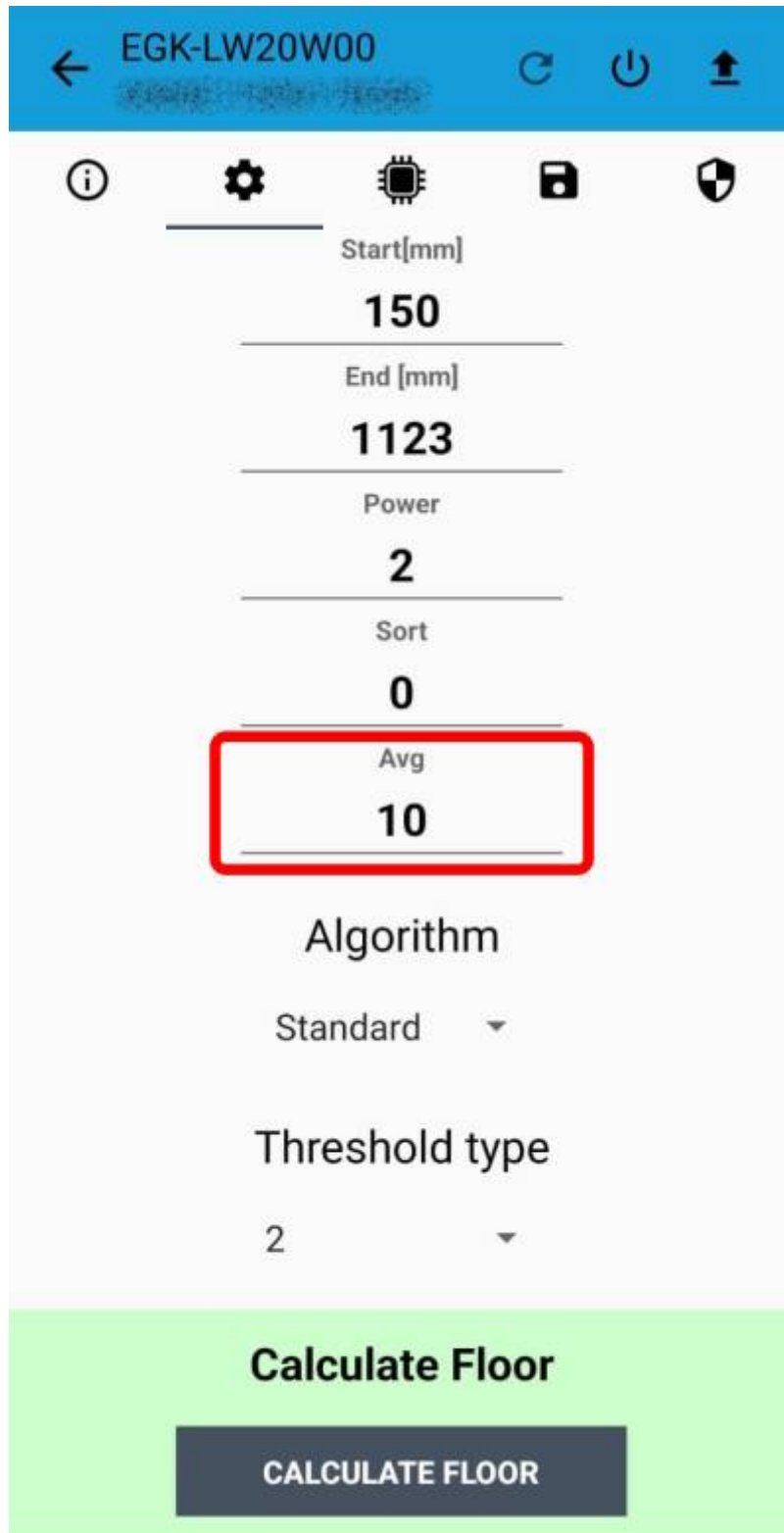

Default: 10

### 3.1.6 Algorithm

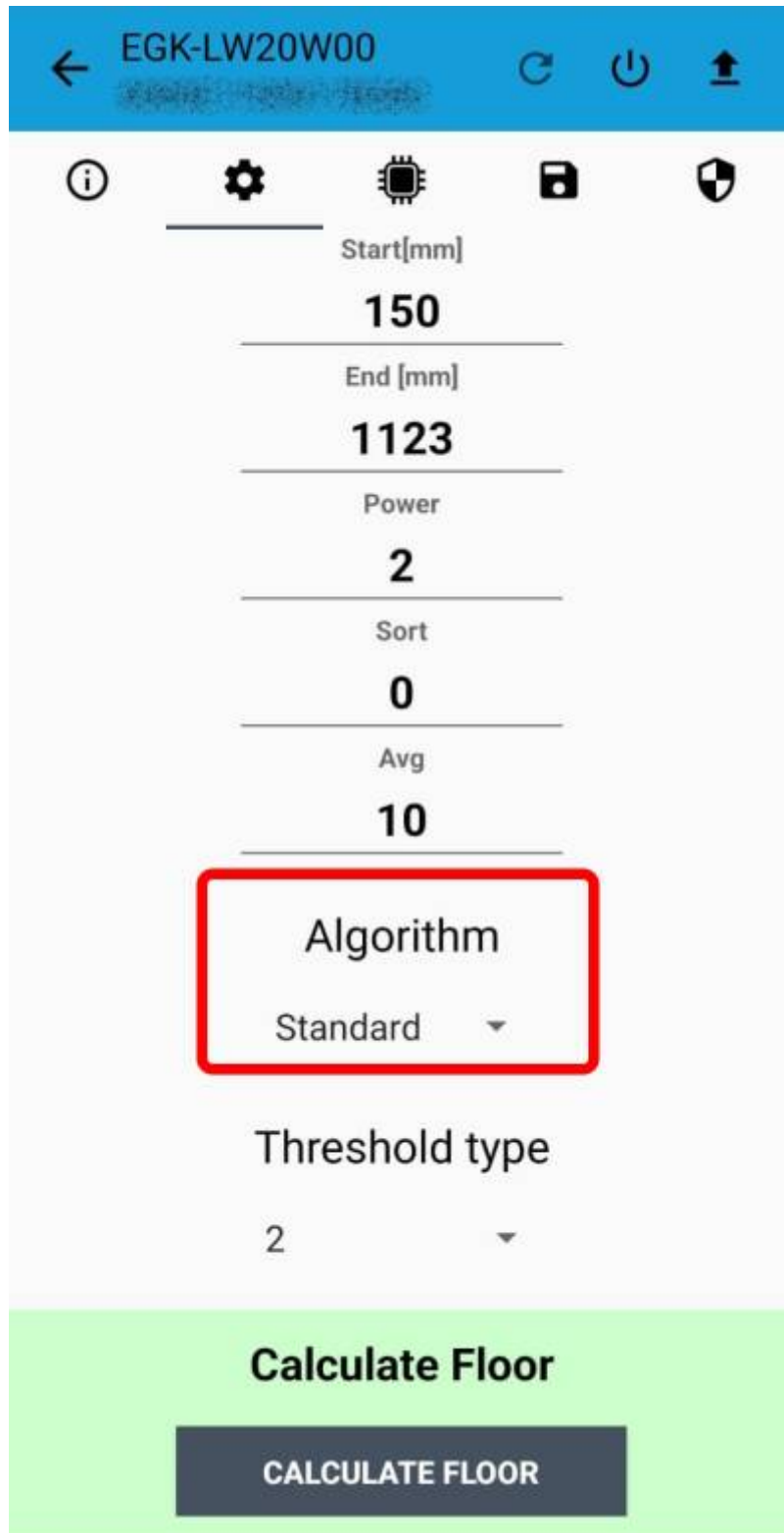

Default: Standard

### 3.1.7 Threshold type

Values can be set from 0 to 2:



Default: 2

### 3.2 Input

The input status represents the status of the accelerometer (Input = 1 start of accelerometer event start, input = 0 end of accelerometer event).

## 4 LoRaWAN network

The sensor is compliant with LoRaWAN® specification 1.0.2.



### 4.1 Activation

The device supports the following activations on a LoRaWAN® network:

1. **NONE**: sensor not activated
2. **OTAA**: the JoinEUI and the AppKey not setted, must be written to the device;
3. **OTAA MCF88**: Over the air activation, fixed keys: JoinEUI = 904e915000000001, AppKey on request;
4. **OTAA ENGINKO**: Over the air activation, fixed keys: JoinEUI = 904e915000000001, AppKey on request;
5. **ABP**: requires writing to the device of NwkSkey, AppSkey, DevAddr.

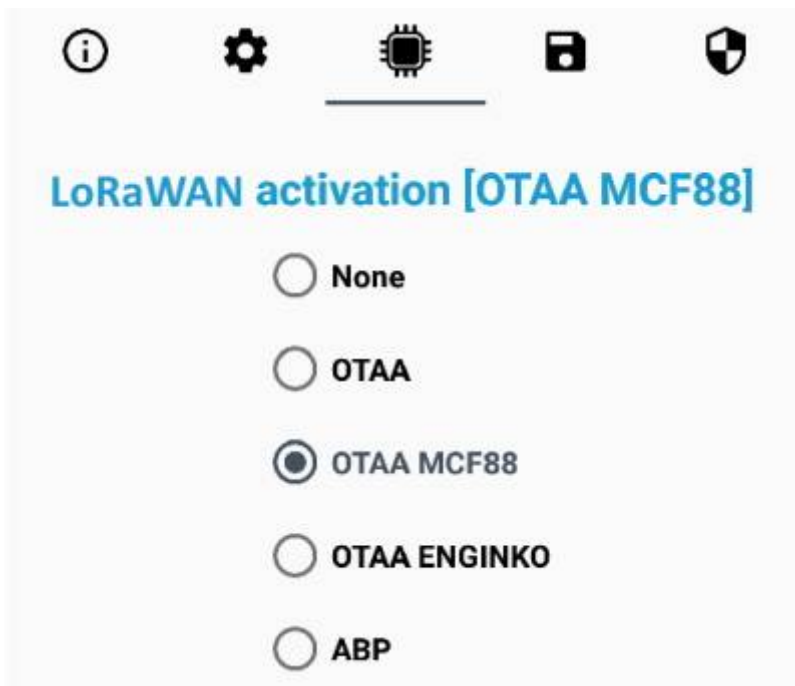

The device exits factory activated with **OTAA ENGINKO** mode. On request devices can be shipped already activated.

Note: in **OTAA** AppKey is write only, in reading the field will always be empty, even if set.

---

### Time sync



Normally sensor asks for a time sync at every power on (uplink starting with 01) or once a week. If no or wrong reply received it will retry after 1 week.

If not handled in the right way can cause a unnecessary battery consumption.

Please check chapter 2.1 [DATA FRAME FORMAT](#).

## 4.2 Other settings

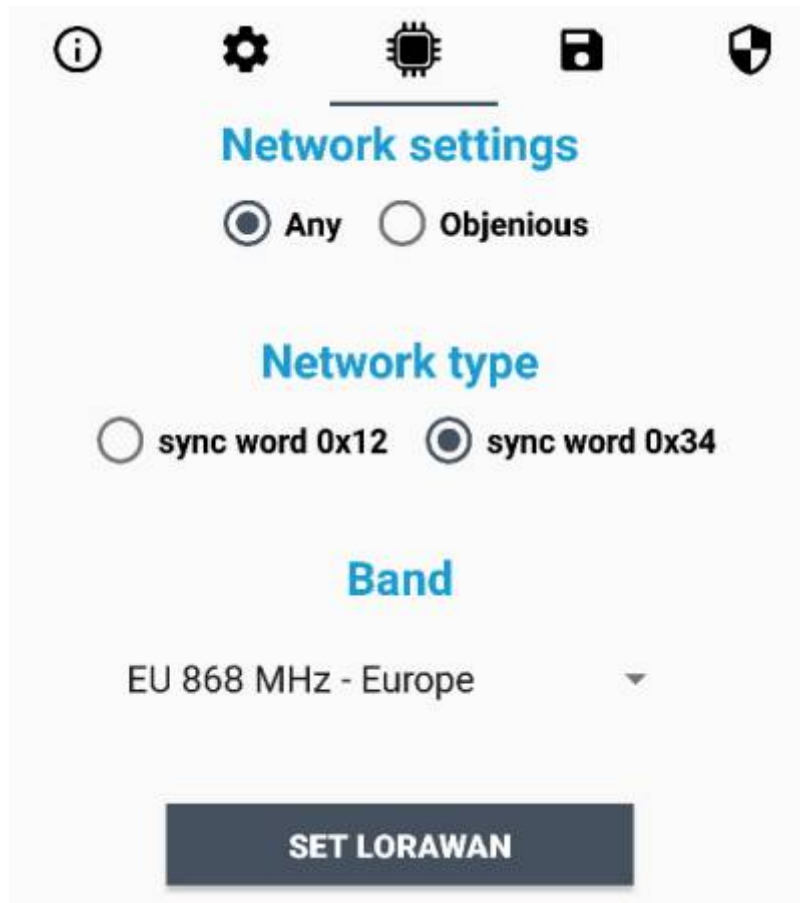

**Network settings:** please keep “Any” settings. Change it only if Objenious network is used (default any).

**Network type:** LoRa syncword can be setted as “private”(0x12) instead “public” (0x34), but the NS must be setted accordingly (default: public).

**Band:** select the right LoRaWAN ® band settings accodngly to country requirements.

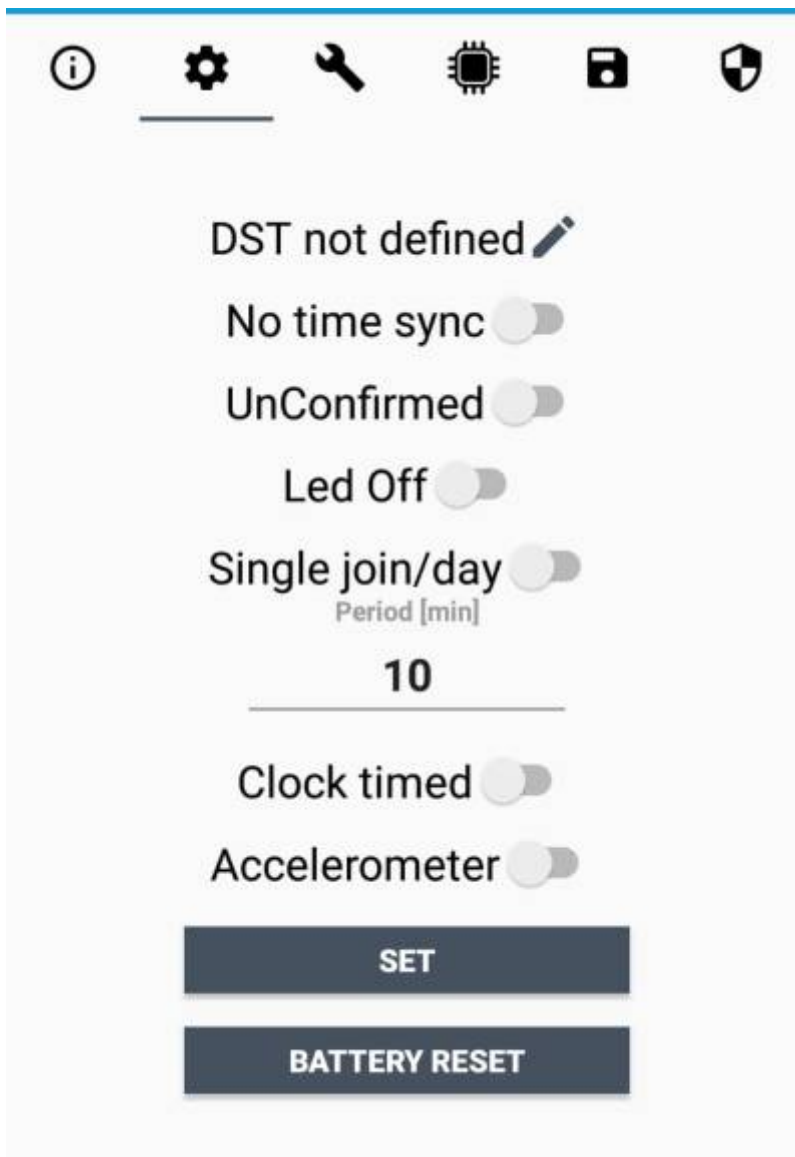

**DST:** set to change DST (default: none).

**No time sync:** set to disable time synchronization request (default: enabled).

**UnConfirmed:** set for unconfirmed uplinks (default: confirmed uplink).

**Led OFF:** set to disable the led.

**Single join/day:** set for to allow only one join per day (default: multiple join allowed).

**Period:** time interval between two measures (in minutes).

**Clock timed:** set to sincronize the reading with the internal clock.

**Accelerometer:** set to enable asynchronous measure in case of shaking. After the first accelerometer event, the device will not send any message for 3 minutes after the last accelerometer event:

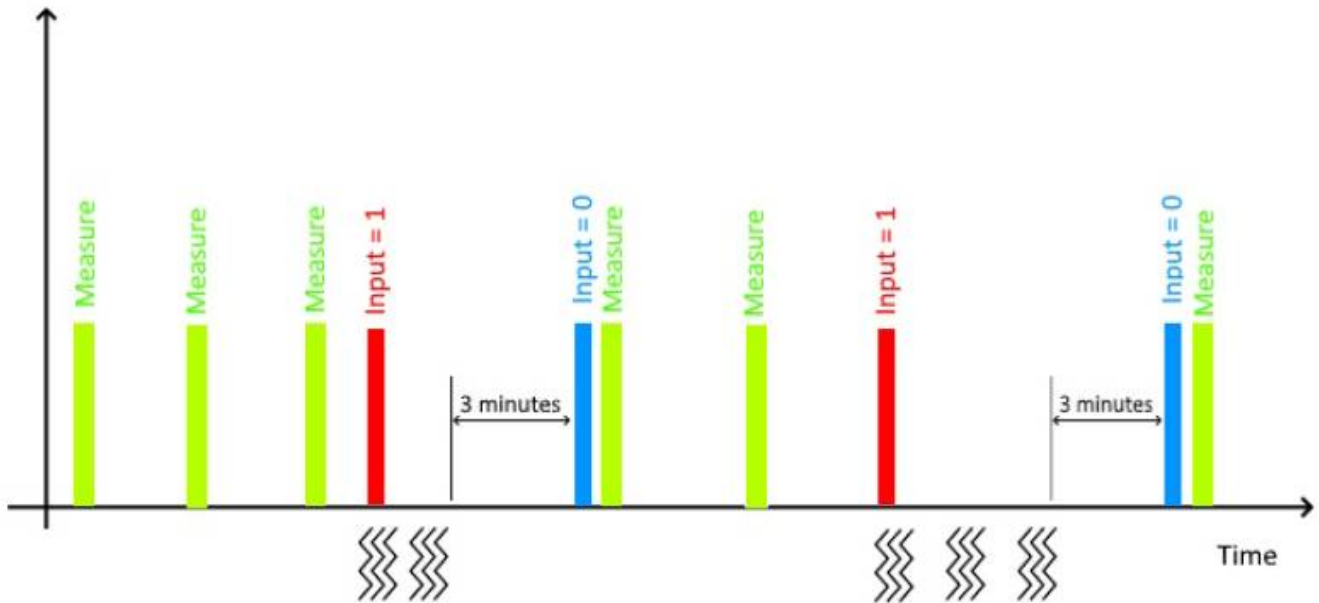

## 5 Passwords

The device can be protected by passwords, to avoid unauthorized persons to read data or modify parameters.

As default passwords are equal to 0.

Allowed values range from 0 to 999999999 (only numbers).

To change the passwords, set the new values with the LoRa Tool App:

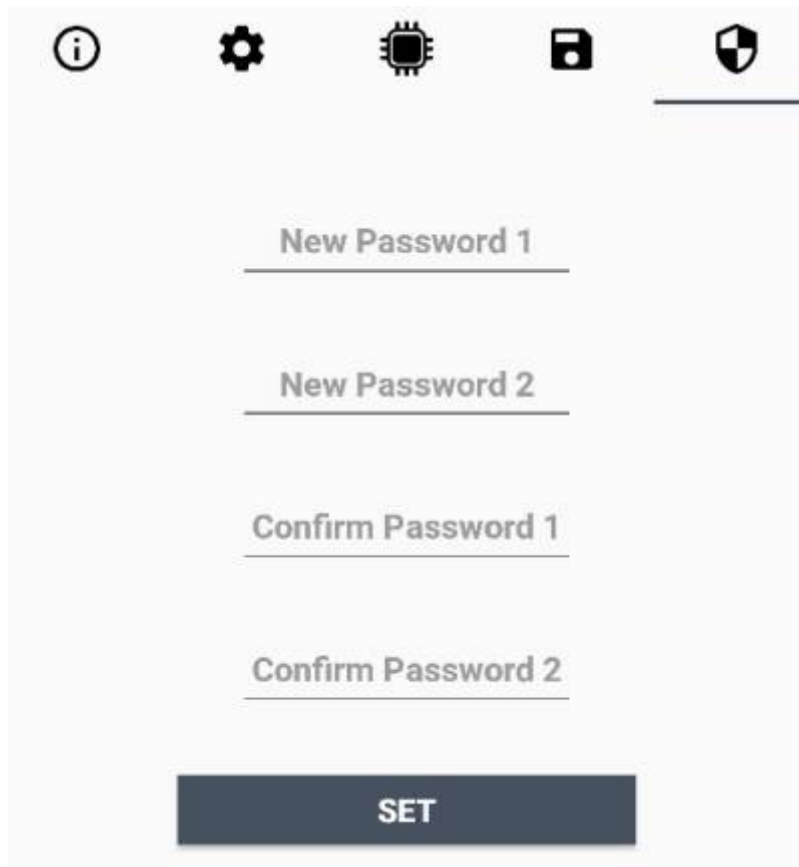

Once the passwords are setted, to gain access from LoRa Tool to the sensor, open the App:



and set the right values before reading from the device:

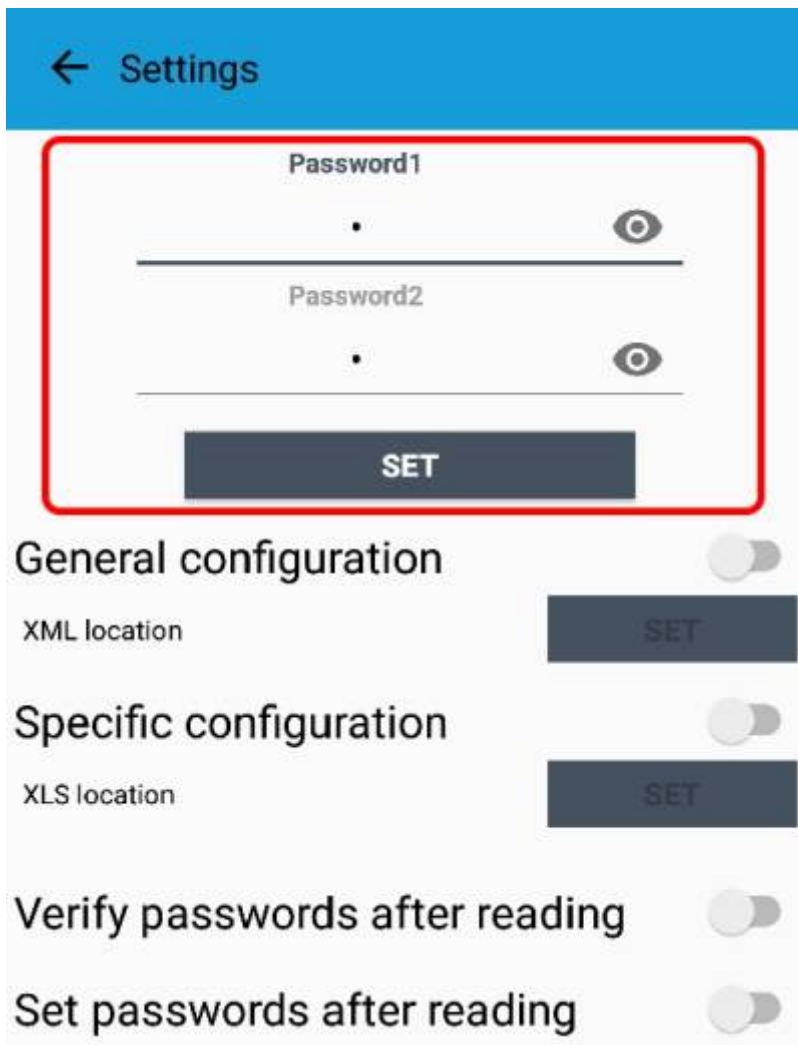

To bring back the sensor to factory default and reset the passwords, a reset code must be requested to Angel4Future (please provide the DevEUI of the sensor when you ask for that code).

## 6 Configuration file

With LoRa Tool App is possible to configure the device using an XML file, instead to manually adjust the parameters (for details about the file format please ask to Angel4Future). This is very useful especially in case of multiple devices configuration.

With “Save” button an XML file with the actual configuration of the sensor will be generated. This is useful to store or clone the configuration, or to send it to Angel4Future's support if needed.



## 6.1 Multi devices configuration

With LoRa Tool App is possible to configure many devices in an easy way.

For multi-configuration is needed at least one XML file with the parameters to set.

Settings on this file will be applied to all the sensors.

With an additional XLS file is possible to load different LoRa configuration parameters (Activation Type, AppKey, AppEUI, NetKey, DevAddress, Band, Private option) for each sensor, based on DevEUI.

When the sensor is approached, if one parameter is different from files, the APP will ask you if you want to overwrite.

XLS is prevailing on the XML, so if both files are enabled, if the DevEUI of the device matches one of the DevEUIs in the XLS file, LoRa parameters will be setted from this one.

These configuration can be done in the in the Settings:

- Enable or disable the use of the general configuration by file;
- Enable or disable the use of the specific configuration by file;
- Verify the passwords;
- Writing the passwords.

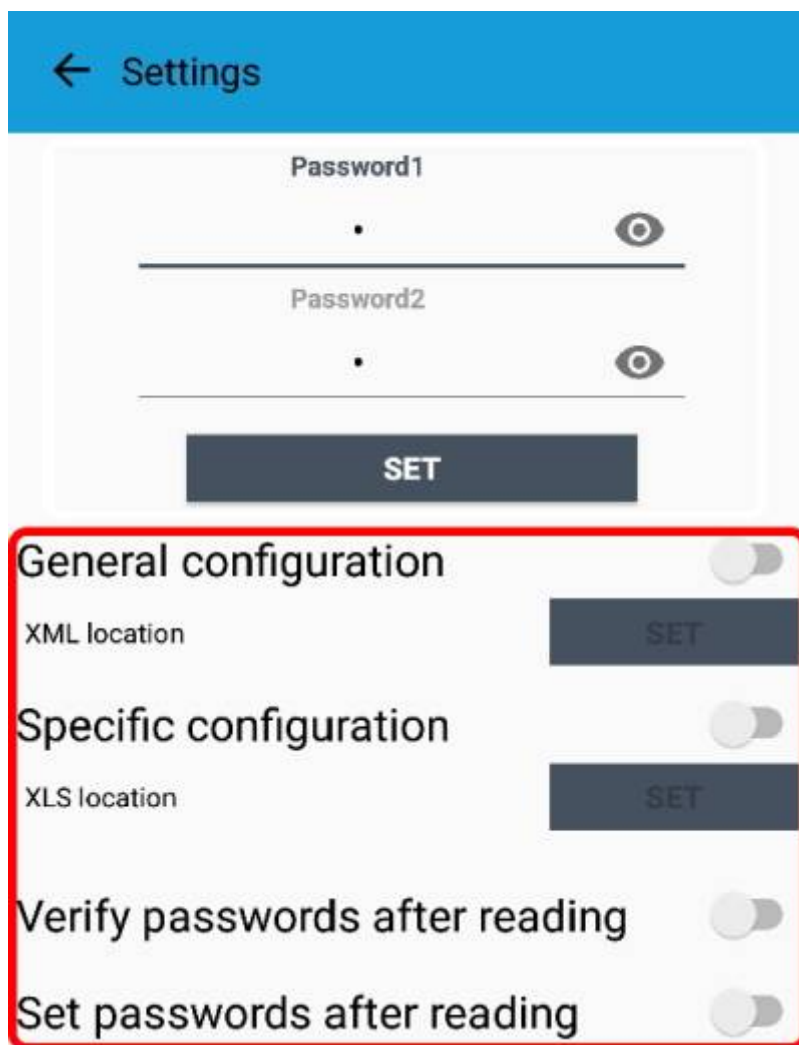

For details on files format please ask to Angel4Future.

## 7 LoRaWEB Tool

Angel4Future provides free **LoRaWEB** online tool, where for each sensor it is possible to find documentation, javascript examples for parsing, downlink generator and uplink decoder:

[LoRaWEB Tool](http://iot.mcf88.cloud/LoRaWeb) (iot.mcf88.cloud/LoRaWeb)

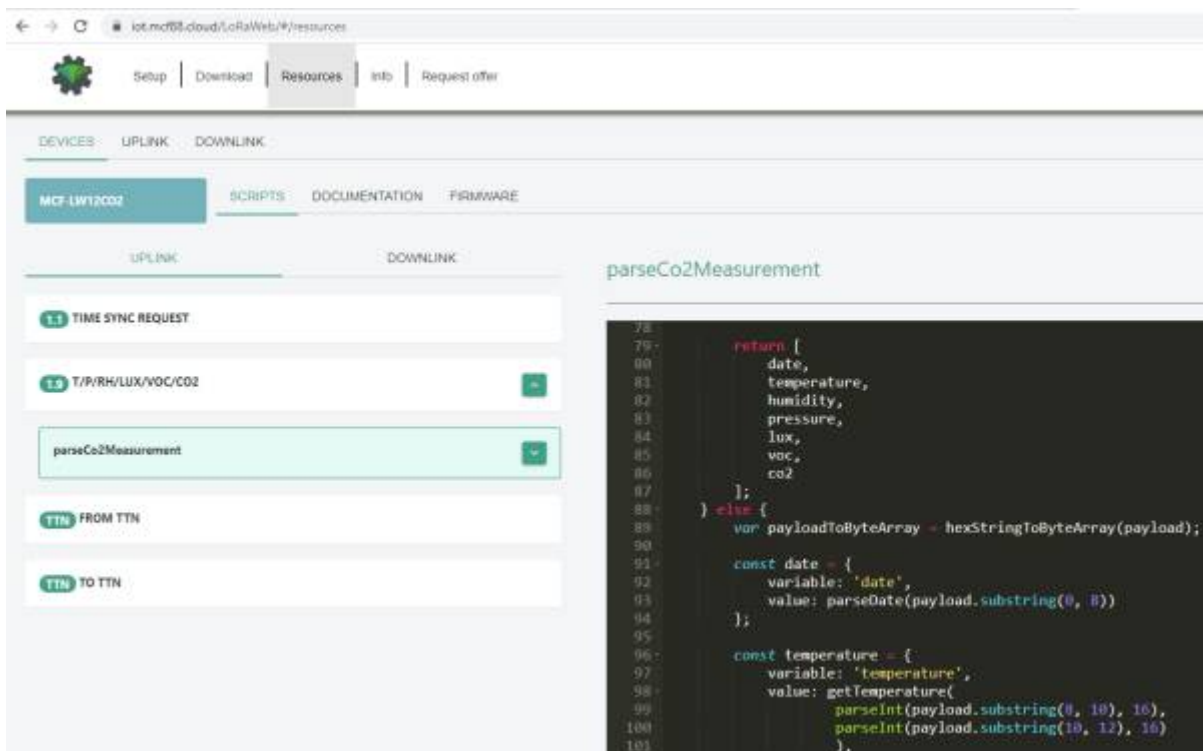
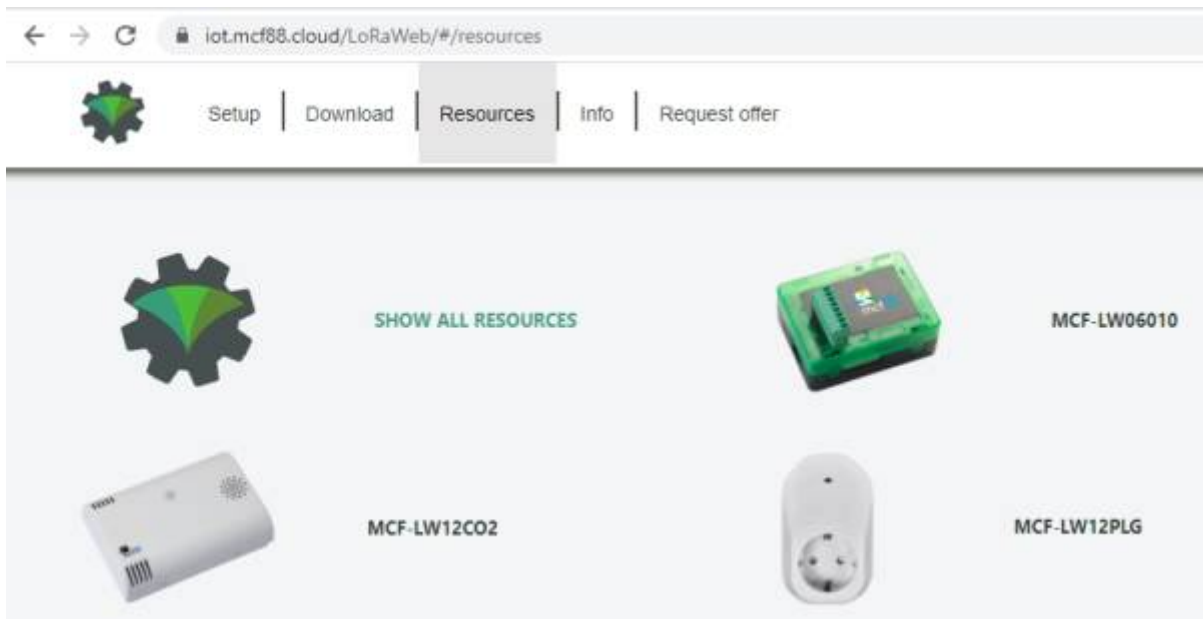

## 8 Payload

For payload descriptions, uplinks and downlinks format and available commands please refer to this document:

[DATA FRAME FORMAT](#)

## 9 Ordering code

Ordering Code	Description
EGK-LW20W00	LoRaWAN® waste level sensor
EGK-RAWALL	Wall mount bracket

## 10 Declaration of conformity

Declarations of conformity are available from Angel4Future by sending a request email to [sensor@enginko.com](mailto:sensor@enginko.com).

## 11 Contacts

### Angel4Future S.r.l.

Via San Sabino 21 - 70042 MOLA DI BARI (BA) , ITALY

T : +39 080 532 1796

E : [info@angel4future.com](mailto:info@angel4future.com)

W: [enginko.com](http://enginko.com)

---

Document rev. 5

---

From:

<https://enginko.com/support/> - **enginko.support.center**

Permanent link:

[https://enginko.com/support/doku.php?id=manual\\_egk-lw20w00&rev=1740742585](https://enginko.com/support/doku.php?id=manual_egk-lw20w00&rev=1740742585)

Last update: **2025/02/28 12:36**

